

---

---

# 2015 Maryland Soil Erosion and Sediment Control Standards and Specifications for Forest Harvest Operations



**Maryland Department of the Environment  
Maryland Department of Natural Resources  
and the State Soil Conservation Committee**

1800 Washington Boulevard  
410-537-3000

Larry Hogan, Jr., *Governor*

| Baltimore, MD 21230-1718 |

| 800-633-6101 |

| Boyd K. Rutherford, *Lt. Governor* |

[www.mde.maryland.gov](http://www.mde.maryland.gov)

TTY Users 800-735-2258

Ben Grumbles, *Secretary*



## ACKNOWLEDGEMENTS

This document was prepared by the Maryland Department of the Environment (MDE) – Water Management Administration (WMA), in cooperation with the Maryland Department of Natural Resources - Forest Service (DNR-FS), the State Soil Conservation Committee (SSCC), and the University of Maryland Extension Service.

Technical assistance during the early drafts was provided by members of: the Maryland Forests Association; the Association of Forest Industries, Inc.; the Maryland State Soil Conservation Districts (SCD); and the Natural Resources Conservation Service (NRCS).

The committee that developed this final edition appreciates those members of the community who took the time to review and comment on the early drafts.

Special thanks go to current and former MDE-WMA and DNR-FS staff, including Raymond Bahr, Deborah Cappuccitti, Amanda Malcolm, Amanda Sigillito, Paul Stoner, Charles Wallis, and especially Fred Jones and Jack Perdue, for their work with developing the 2005 draft manual. Their expertise and thoroughness was evident and appreciated when it came to bringing this project to fruition.

The members of SCD and NRCS representing the State Soil Conservation Committee during the 2005 process included: Pete Cruikshank, Larry Fykes, Nancy Metcalf, Roger Thomas, Lindsay Tulloch, and Bruce Young. Their contributions added technical insight and practical experience at critical junctures.

Finally, the completion of this 2015 Manual was a result of the persistence of DNR-FS, especially Daniel Rider, with oversight by MDE-WMA, including Maria Warburton. Manual production was coordinated by Lou Hyman of the University of Maryland Extension, who served as facilitator and editor of this process.

## INTRODUCTION

In 2003, the Maryland Department of the Environment (MDE) began the process of revising the then 20-year-old *Soil Erosion and Sediment Control Guidelines for Forest Harvest Operations in Maryland*. As can be seen by the long list of acknowledgements, many people and organizations were involved in the process. A draft version was developed and distributed for review and comments in early 2005.

Subsequently, MDE's focus shifted to revising the urban soil erosion and sediment control manual with the "2011 *Maryland Standards and Specifications for Soil Erosion and Sediment Control*," issued in January 2012.

Recognizing the inherent differences between soil erosion and sediment control for urban development and for forest harvest operations, the finalizing of the 2005 draft forest harvest manual was undertaken in late 2014. This task has involved the Maryland Department of Natural Resources (DNR), MDE, and University of Maryland Extension. It builds on the 2005 draft, comments received during the 2005 draft process, and current laws and regulations. By staying focused on the goal of protecting water quality while recognizing the uniqueness of forest harvest operations, this final document aims to be both practical and effective, for the regulated industry that lives by it, the regulators who implement it, and stakeholders and the general public who benefit from it. MDE anticipates that standards and specifications will continue to evolve as technology, law, and environment all change.

All Marylanders will benefit from the *2015 Maryland Soil Erosion and Sediment Control Standards and Specifications for Forest Harvest Operations (Manual)* - as the State of Maryland continues to ensure protection of the Waters of the State, including our streams, rivers, and the Chesapeake and Coastal Bays.

Lynn Buhl, Director, Water Management Administration



## LIST OF TABLES

Table 1	– Summary of Soil Erosion and Sediment Control Plan Approval Options.....	8
Table 2	– SMZ Width vs. Site Slope .....	22
Table 3	– Broad-Based Dip Spacing vs. Road Grade.....	43
Table 4	– Rolling Dip Spacing vs. Road Grade.....	46
Table 5	– Water Bar Spacing vs. Road Grade .....	47
Table 6	– Cross-Road vs. Road Grade.....	53
Table 7	– Straw Bale Dike Slope Length and Steepness Design Criteria .....	75
Table 8	– Silt Fence Slope Length and Fence Length Design Criteria.....	78
Table 9	– Nurse Crops (Temporary Seeding).....	82
Table 10	– Permanent Seeding Mixtures .....	83-84
Table 11	– Area Determinations for Roads .....	84
Table 12	– Sample Seed Application Rates .....	84

## LIST OF DIAGRAMS

Diagram 1.0	– Application for Standard Soil Erosion and Sediment Control Plan for Forest Harvest Operations.....	25
Diagram 2.0	– Streamside Management Zone.....	30
Diagram 3.0	– Streamside Management Zone Plan.....	31
Diagram 4.0	– Stabilized Harvest Entrance.....	34
Diagram 5.0	– Broad-Based Dip.....	44
Diagram 6.0	– Rolling Dip.....	46
Diagram 7.0	– Water Bars .....	49
Diagram 8.0	– Water Turnouts .....	51
Diagram 9.0	– Pipe Culvert Installation .....	54
Diagram 9.1	– Open Top Box and Pole Culverts .....	55
Diagram 10.0	– Temporary Access Waterway Crossing – Bridge.....	60
Diagram 10.1	– Portable Skidder Timber Bridge Design.....	61
Diagram 10.1.a	– Portable Skidder Timber Bridge Design: Material List .....	62
Diagram 10.1.b	– Portable Skidder Timber Bridge Design: Isometric View .....	63
Diagram 10.1.c	– Portable Skidder Timber Bridge Design: Sections .....	64
Diagram 10.1.d	– Portable Skidder Timber Bridge Design: Notes .....	65
Diagram 11.0	– Temporary Access Waterway Crossing – Culvert.....	68
Diagram 12.0	– Temporary Access Waterway Crossing – Ford .....	71
Diagram 13.0	– Logging Mats.....	73
Diagram 14.0	– Straw Bale Dike .....	76
Diagram 15.0	– Silt Fence .....	79

## **LIST OF ABBREVIATIONS USED IN THIS MANUAL**

BMP	Best Management Practice
COMAR	Code of Maryland Regulations
DBH	Diameter Breast Height (4.5 feet above Ground Level)
DNR	Department Of Natural Resources
DNR-FS	Department Of Natural Resources-Forest Service
FCA	Forest Conservation Act
FS	Forest Service
ft.	Foot (Measurement)
H:V	Horizontal To Vertical (Slope)
lbs.	Pounds
LPF	Licensed Professional Forester
MD	Maryland
MAX	Maximum
MDE	Maryland Department of the Environment
MDE-WMA	Maryland Department of the Environment-Water Management Administration
MIN	Minimum
NRCS	Natural Resources Conservation Service
NTW	Nontidal Wetlands
NTWSSC	Nontidal Wetlands of Special State Concern
PDA	Public Drainage Association
SCD	Soil Conservation District
SMZ	Streamside Management Zone
sq. ft.	Square Feet
USGS	United States Geological Survey
WMA	Water Management Administration

# TABLE OF CONTENTS

Acknowledgements.....	i
Introduction.....	ii
List of Tables .....	iii
List of Diagrams .....	iii
List of Abbreviations Used in this Manual.....	iv
<b>Table of Contents .....</b>	<b>v-vii</b>
Appendices.....	vii
<b>Forest Harvest Operations in Maryland.....</b>	<b>1-3</b>
History of Maryland’s Sediment Control Program.....	1
Legal Requirements .....	1-2
Waters of the State .....	2-3
<b>Erosion and Sediment Control Plans .....</b>	<b>4-8</b>
Obtaining an Approved Erosion and Sediment Control Plan.....	4
Appropriate Plan Type: Standard or Custom.....	4
Requirements of the Standard Erosion and Sediment Control Plan .....	5
Requirements of the Custom Erosion and Sediment Control Plan .....	6
Requirements of the Streamside Management Zone and SMZ Plan.....	7
<b>Related Erosion and Sediment Control Information .....</b>	<b>9-10</b>
Three/Seven Day Stabilization Requirement.....	9
Responsible Personnel Certification Training .....	9
Delegation of Inspection and Enforcement Authority .....	9
Plan Certification by a Professional.....	10
Landowner Responsibility .....	10
<b>Wetland Considerations .....</b>	<b>11-12</b>
Nontidal Wetlands (NTW).....	11
Procedures for Forestry Activities .....	11
Best Management Practices .....	12
Nontidal Wetlands of Special State Concern (NTWSSC).....	12
Chesapeake Bay Critical Areas.....	12
<b>Related Issues .....</b>	<b>13-14</b>
Waterway Construction Permits .....	13
County Permits .....	13

## TABLE OF CONTENTS

<b>Related Issues (Continued)</b> .....	<b>13-14</b>
Soil Conservation Districts .....	13
Invasive Plant Species.....	14
Forest Conservation Act .....	14
<b>Forestry Best Management Practices</b> .....	<b>15-16</b>
Forestry Activities – Water Quality Relationships .....	16
<b>Introduction to the Use of the Specifications</b> .....	<b>17-18</b>
<b>SPECIFICATIONS for:</b> .....	<b>19-84</b>
<b>[CATEGORY 1: Planning and Streamside Management Zone]</b> .....	<b>19-31</b>
Pre-Harvest Planning .....	19
Soil Erosion and Sediment Control Plan for Forest Harvest Operations in Maryland (The Standard Plan) .....	20-25
Streamside Management Zone (SMZ).....	26-31
<b>[CATEGORY 2: Erosion Control of Roads and Trails]</b> .....	<b>32-79</b>
Stabilized Harvest Entrance .....	32-34
Truck Haul Roads .....	35-37
Skid Trails.....	38-39
Log Decks and Landings .....	40-41
Broad-Based Dip.....	42-44
Rolling Dip.....	45-46
Water Bars .....	47-49
Water Turnouts .....	50-51
Cross-Road Drainage.....	52-55
Temporary Access Waterway Crossings .....	56-71
<i>General Requirements</i> .....	56-57
<i>Bridge</i> .....	58-65
<i>Culvert</i> .....	66-68
<i>Ford</i> .....	69-71
Logging Mats .....	72-73
Straw Bale Dike .....	74-76
Silt Fence.....	77-79
<b>[CATEGORY 3: Revegetation of Disturbed Soils]</b> .....	<b>80-84</b>
Revegetation of Disturbed Soils .....	80-84
<b>Glossary</b> .....	<b>85-92</b>

## APPENDICES

<b>APPENDICES</b>	<b>Cover Page</b> .....	<b>93</b>
<b>APPENDIX A:</b>	<b>Forest Harvest Erosion and Sediment Control Plan Decision Flow Chart</b> .....	<b>95</b>
<b>APPENDIX B:</b>	<b>Examples of Erosion and Sediment Control Plans</b> .....	<b>96-117</b>
B.1.	Standard Erosion and Sediment Control Plan for Forest Harvest Operations (The Standard Plan) - Basic .....	97-101
B.2.	Standard Plan - Complex .....	102-106
B.3.	SMZ Plan .....	107-108
B.4.	Custom Plan – No Work in the SMZ.....	109-112
B.5.	Custom Plan – Includes SMZ Issues .....	113-117
<b>APPENDIX C:</b>	<b>USDA, NRCS Code 342</b> .....	<b>119-142</b>
<b>APPENDIX D:</b>	<b>Agency Contacts</b> .....	<b>143-148</b>
D.1.	Soil Conservation District Offices .....	143-144
D.2.	Maryland Department of the Environment .....	145
D.3.	Department of Natural Resources – Maryland Forest Service .....	146-148
<b>APPENDIX E:</b>	<b>Forest Conservation Act (FCA)</b> .....	<b>149</b>
<b>APPENDIX F:</b>	<b>Critical Area Commission for the Chesapeake and Atlantic Coastal Bays – Contacts</b> .....	<b>150-156</b>
F.1.	Commission Contacts .....	150
F.2.	Chesapeake and Atlantic Coastal Bays Critical Areas - Information .....	151-154
F.3.	Procedural Requirements .....	155-156
<b>APPENDICES G-I:</b>	<b>Waterway and Wetland Regulations</b> .....	<b>157-164</b>
APPENDIX G:	General Waterway Construction Permit.....	159
APPENDIX H:	Nontidal Wetlands Forestry Activities.....	160-162
APPENDIX I:	Nontidal Wetlands Plan Review and Approval for Forestry Activities.....	163-164
<b>APPENDIX J:</b>	<b>Standards and Specifications for Geotextile Materials</b> .....	<b>165</b>
<b>APPENDIX K:</b>	<b>References</b> .....	<b>166</b>



# FOREST HARVEST OPERATIONS IN MARYLAND

## History of Maryland's Sediment Control Program

The General Assembly of Maryland has long recognized that the State's watersheds are great natural assets and resources. Sediment deposition from erosion caused by earth-disturbing activities contributes to these waters being polluted and despoiled to such a degree that aquatic plants and animals, and recreational use have been affected adversely.

To protect the State's natural resources, including its water resources, the Maryland General Assembly passed laws requiring the *Maryland Department of the Environment* (MDE) to adopt criteria and procedures to implement a State-wide erosion and sediment control program. This program places the responsibilities of reviewing and approving required erosion and sediment control plans at the local level. Typically, the local *soil conservation district* (SCD) is designated as the technical expert for most counties and, as such, reviews and approves the erosion and sediment control plans for private and local government projects. The State retains the ultimate enforcement authority for the erosion and sediment program, but allows for the delegation of authority to counties and other jurisdictions on a case-by-case basis.

Essentially, any non-agricultural, land-disturbing activity is regulated under the sediment control program, including forest harvest operations. The State's sediment control program recognizes that the failure to fully implement and maintain approved erosion and sediment control plans has acute and cumulative effects on the environment. The program, therefore, provides for obtaining immediate compliance with the law when violations occur.

## Legal Requirements

Any forest harvest operation that disturbs more than 5,000 square feet or 100 cubic yards of soil must have an approved erosion and sediment control plan<sup>1</sup>. Plan requirements may differ based on site conditions and the proposed forest harvest operation. This Manual, the *2015 Maryland Erosion and Sediment Control Standards and Specifications for Forest Harvest Operations*, provides guidance on the requirements for plan approval, and the various erosion and sediment control practices that may need to be implemented. ***It is important to note that in addition to any plan requirements, both the landowner and operator have a legal obligation during a forest harvest operation to take action to minimize erosion and to prevent sedimentation and pollution of Waters of the State.***

Unlike the typical construction project, most forest harvest erosion and sediment control plans do not require perimeter sediment controls around an entire limit of disturbance. Although physical controls, such as silt fence and broad-based dips are sometimes required, *Best Management Practices* (BMPs), including the careful placement of roads, skid trails, and landings, are relied upon to reduce erosion and control sedimentation. These practices, as well as stabilization specifications and *Streamside Management Zones* (SMZ) are presented in this Manual.

---

<sup>1</sup> See the *Annotated Code of Maryland*, Environment Article, Title 4, Water Management, Subtitle 1 Sediment Control, §4-101 through 4-116 and the Code Of Maryland Regulations, (COMAR) 26.17.01.01 through 26.17.01.11

In addition to erosion and sediment control, there are three other general environmental areas involving forest harvests in Maryland that have legal requirements and which are introduced briefly in this Manual:

1. Nontidal Wetlands (Appendix H).
2. Waterway Construction, (stream crossings, Appendix G).
3. Chesapeake and Atlantic Coastal Bays Critical Areas (Appendix F).

For a more detailed explanation of these requirements, contact the local SCD, the *Maryland Department of Natural Resources - Forest Service* (DNR-FS), or MDE. See the appropriate Appendices for the specific contacts, addresses, and phone numbers.

## **Waters of the State and Pollution Prevention**

The legal definitions of *Waters of the State* and *pollution* are fundamental to Maryland's efforts to protect the environment. An understanding of the definition also is necessary in order to fully and accurately utilize this Manual. Both definitions are included in the *Code Of Maryland Regulations* (COMAR) 26.17.01.01 (Department of Environment, Water Management, Erosion and Sediment Control, Definitions). They read as follows:

B. (30) "Waters of the State" includes:

- (a) Both surface and underground waters within the boundaries of the State subject to its jurisdiction, including that portion of the Atlantic Ocean within the boundaries of the State, the Chesapeake Bay and its tributaries, and all ponds, lakes, rivers, streams, storm drain systems, public ditches, tax ditches, and public drainage systems within the State, other than those designated and used to collect, convey, or dispose of sanitary sewage; and
- (b) The flood plain of free-flowing waters determined by the Department on the basis of the 100-year flood frequency.

B. (17) "Pollution" means the contamination or other alteration of the physical, chemical, or biological properties of any Waters of the State, including change in temperature, taste, color, turbidity, or odor of the waters, or the discharge or deposit of any organic matter, harmful organisms, liquid, gaseous, solid, radioactive, or other substance into any Waters of the State that will render the waters harmful, detrimental, or injurious to:

- (a) Public health, safety or welfare;
- (b) Domestic, commercial, industrial, agricultural, recreational, or other legitimate beneficial uses; or
- (c) Livestock, wild animals, birds, fish, or other aquatic life.

These definitions are intentionally broad and deep, and cover any activity throughout the entire State that has the potential to have a negative impact on Waters of the State. Care must be taken during and following a forest harvest operation to ensure that pollution does not occur to Waters of the State as a result of forest harvest activity. Additionally, it is important to know where Waters of the State exist on a site to avoid crossing or otherwise disturbing them where possible,



and to obtain the required permits when disturbance or the installation of a crossing is unavoidable.

As noted under Legal Requirements above, forest harvest erosion and sediment control strategies rely heavily on the implementation of BMPs. This rationale is based on the knowledge that preventing erosion is much more effective for protecting water quality than attempting to remove sediment from a sediment-laden discharge. Thus, an undisturbed forest can be an effective erosion and sediment control measure for timber harvest activities. In such a condition, rainfall runoff should exist in sheet flow condition, sediment-laden runoff caused by the timber harvest operation will be minimized, and any suspended sediment will settle out by flowing across the width of undisturbed forest before reaching Waters of the State.

Sound pre-harvest planning is essential to an effective erosion and sediment control plan that includes the use of effective BMPs and the installation of other erosion and sediment control practices, where necessary, to prevent pollution to Waters of the State.

This planning includes identifying all Waters of the State on a project. If a crossing is proposed of any Waters of the State, a Waterway Construction Permit may be required. Additionally, a SMZ must be established along all blue line streams. If harvesting is proposed within a SMZ, a SMZ plan must be designed and approved.

More information about erosion and sediment control plans, SMZ plans, BMPs, standards and specifications, and Waterway Construction Permits is presented in detail in the following sections of this Manual.

## **EROSION AND SEDIMENT CONTROL PLANS**

### **Obtaining an Approved Erosion and Sediment Control Plan**

Maryland State law and regulations require that an erosion and sediment control plan be developed and approved before undertaking any earth-disturbing activity in excess of 5,000 square feet or 100 cubic yards. This requirement applies to construction on residential, commercial, industrial, and institutional sites as well as on forest harvest projects. To assist loggers with meeting this requirement, MDE and DNR have developed *The Standard Erosion and Sediment Control Plan for Forest Harvest Operations in Maryland* (Standard Plan).

The Standard Plan covers most basic harvest sites, includes general erosion and sediment control requirements for a harvest operation, and may be obtained at any SCD office. For sites that exceed the limits of the Standard Plan, a *Custom Erosion and Sediment Control Plan* (Custom Plan) must be designed specifically for the site and submitted to the local SCD for review and approval.

Additionally, if the harvest site includes removing trees adjacent to a stream or other water body, a SMZ Plan may be required. The next five sections help the applicant to select the type of approval(s) needed for a specific site and what each requires.

### **Appropriate Plan Type: Standard or Custom**

It is anticipated that a significant portion of the forest harvest operations conducted in Maryland can be approved under the Standard Plan. A Standard Plan may be used if all of the following conditions are met:

1. Road cuts/fills are 3 feet or less (5 feet in Garrett, Allegany, Washington, and Frederick counties).
2. Grades for haul roads do not exceed 15 percent.
3. Landings are located on slopes 10 percent or less.
4. Grades for skid trails do not exceed 20 percent.

If any of these conditions or any other criteria of the Standard Plan cannot be met, a Custom Plan must be developed.

## Requirements of the Standard Erosion and Sediment Control Plan

The potential for sediment loss from a forest harvest site is greatest at three general locations: (1) entrance to the site; (2) forest access system (haul roads, skid trails, and landings); and (3) adjacent to watercourses. The Standard Plan, therefore, emphasizes sediment control in these locations. Instructions for installing the required sediment control practices are listed in the specifications sections of this Manual. (See Appendix B for examples that are based upon actual Standard Plans that have been reviewed and approved.) The primary requirements for these locations are as follows:

1. **Site Entrance:** Access points to and from the site must be protected. Materials such as stone, wood chips, corduroy mats, or logging mats are used to minimize the soil or mud being tracked onto the road. It also is necessary to prevent an existing roadside ditch from being blocked or damaged by access to the site. A culvert placed underneath the entrance is the most effective way to maintain proper drainage.
2. **Trails and Landings:** Advanced pre-harvest planning of the location of roads, skid trails, and landings is an effective way to minimize the potential for soil erosion. Locating roads and trails along natural contours and minimizing slopes will reduce the need for substantial cutting and filling operations.
3. **Waterway Protection:** Avoid stream crossings whenever possible, as they create one of the greatest potentials for sediment erosion and pollution. If a crossing is unavoidable, a temporary Waterway Construction Permit may be required unless the channel is bridged or otherwise spanned (Appendix G). A Waterway Construction Permit is required for all in-stream culvert or ford installations. Protecting watercourses from runoff and equipment damage is the most critical aspect of sediment control during harvest operations. Improper stream crossings, soil disturbance adjacent to streams, and logging debris left in streams may result in substantial sediment pollution and flooding.

The Standard Plan includes requirements for working near Waters of the State. When a blue line stream exists on site, establishing a SMZ is also required. A SMZ plan must accompany the Standard Plan if any harvesting is proposed within the SMZ<sup>2</sup>.

**NOTICE: Additional Requirements.** In addition to the practices listed for the above areas, it is necessary to stabilize certain portions of the harvest site with seed and mulch to prevent erosion. This requirement generally applies to roads, trails, and landings.

---

<sup>2</sup> See the following sections in this Manual: Specifications for the Standard Erosion and Sediment Control Plan for Forest Harvest Operations in Maryland and the Specifications for Streamside Management Zone for more information regarding requirements for working around Waters of the State.

## **Requirements of the Custom Erosion and Sediment Control Plan**

Situations may arise when it is not possible, even with careful planning, to comply with all the requirements of the Standard Plan. If all the conditions of the Standard Plan cannot be met, it is necessary to have a Custom Plan prepared by a *Maryland Licensed Professional Forester* (LPF). A Custom Plan must be reviewed and approved by the appropriate approval authority, typically the local SCD.

Two pieces of information must be included in a Custom Plan. The first is a description of the Standard Plan requirements that cannot be met; the second is the specific erosion and sediment control measure(s) to be used for the forest harvest operation. A sketch or map of the harvest site that identifies this information must be submitted with a Custom Plan. For example, if proposed road grades exceed 15 percent, and turnouts are to be used to drain water from the road, the location of the turnouts must be noted on the sketch. If stone is to be installed at the discharge end of the turnout to prevent side bank erosion, the location of the stone must also be shown.

Another example is locating a landing on a slope exceeding 10 percent. It may be necessary to install a silt fence or a straw bale dike on the downslope side of the landing to act as a sediment filter. In this case, the location of sediment controls and the type of final stabilization to be used at the landing must be noted on the plan.

The local SCD may require certification of a Custom Plan by a professional engineer, land surveyor, landscape architect, architect, or a LPF, verifying that the plan has been designed in accordance with the appropriate erosion and sediment control ordinances, regulations, standards, and criteria. (See discussion under the Related Erosion and Sediment Control Information.)

The SCD has the option to require a specific design if a particular situation demands it. As an example, a proposed haul road exceeds the maximum limits set in the specification. Under such a situation the SCD may require a site-specific design demonstrating that the road will function as intended and remain stable.

In summary, it is important to develop a Custom Plan that identifies the location and describes the specific erosion and sediment controls to be used wherever the Standard Plan requirements cannot be met.

## **Requirements of the Streamside Management Zone and SMZ Plan**

The establishment of a SMZ is required, at a minimum, along all blue line streams. A SMZ is generally required in lieu of structural measures such as silt fence, diversion dikes, and sediment traps.

Harvesting is allowed within a SMZ provided that a SMZ Plan is prepared by a LPF and approved by the SCD. A SMZ Plan must be very specific when describing which trees are to be cut, what precautions for sediment control will be taken, and where the sediment controls will be located. The location of any harvesting within a SMZ must be identified on a sketch of the SMZ. The sediment controls to be used for waterway protection within the SMZ also must be identified on this sketch. If a SMZ Plan is required, it can be used in conjunction with a Standard Plan, providing all other Standard Plan criteria are met. If other conditions of the harvest necessitate a Custom Plan, requirements for harvesting within the SMZ will be made a part of that Plan<sup>3</sup>.

Each site must be evaluated on its own individual characteristics and limitations.

---

<sup>3</sup> See Specifications for Streamside Management Zone and Appendix B.3 for a sample SMZ Plan.

**Table 1**  
**Summary of Erosion and Sediment Control Plan Approval Options**

<b>Harvesting Specifications</b>	<b>Plans / Approvals</b>
<ul style="list-style-type: none"> <li>• Road cuts/fills 3 feet or less (5 feet in Garrett, Allegany, Washington, and Fredrick Counties).</li> <li>• Haul road grades do not exceed 15%.</li> <li>• Landings on slopes of 10% or less.</li> <li>• Skid trail slopes do not exceed 20%.</li> <li>• Uncut and undisturbed SMZ.</li> </ul>	<p align="center">Standard Plan only</p>
<ul style="list-style-type: none"> <li>• Harvests involving a Nontidal Wetland.</li> <li>• Harvest involving a SMZ.</li> <li>• Harvests involving haul roads with slopes between 15% and 20% for a maximum of 200 feet, skid trails with slopes between 20% and 25% for a maximum of 200 feet, or road cuts/fills greater than 3 or 5 feet.</li> <li>• In general, any proposed activity that exceeds the limits set in the Standard Plan.</li> </ul>	<p align="center">Custom Plan (Must be prepared by a LPF)</p>
<ul style="list-style-type: none"> <li>• Harvests involving haul roads with slopes greater than 20%, skid trails with slopes greater than 25% , and landings with slopes greater than 10%.</li> <li>• In general, any proposed activity that exceeds the limits set in the specifications.</li> </ul>	<p align="center">Custom Plan with specific BMP design as directed by the SCD (may require Certification)</p>
<ul style="list-style-type: none"> <li>• Harvesting involving silvicultural activities within a SMZ.</li> </ul>	<p align="center">Standard Plan with SMZ Plan OR Custom Plan (including SMZ issues)</p>

## **RELATED EROSION AND SEDIMENT CONTROL INFORMATION**

### **Three/Seven Day Stabilization Requirement**

The Code Of Maryland Regulations (COMAR) provides that each erosion and sediment control plan, including those pertaining to forest harvest operations, contain language outlining site stabilization requirements<sup>4</sup>. Briefly, this means that following the completion of any perimeter erosion and sediment controls, and cut and fill slopes steeper than 3:1 (horizontal to vertical), stabilization must be accomplished within three (3) calendar days. For all other disturbances, final stabilization must be done in accordance with Specifications for Revegetation of Disturbed Soils. If temporary stabilization is necessary (e.g. to minimize erosion potential), measures may include mats, wood chips, and compacted wood slash.

### **Responsible Personnel Certification Training**

The Annotated Code of Maryland and COMAR require that any person responsible for the implementation and maintenance of an approved erosion and sediment control plan complete a training program approved by MDE. For forest harvest operators, the purpose of this training is to:

- Instruct loggers in the proper implementation and maintenance of erosion and sediment control practices.
- Provide for a better understanding of the necessity to control pollution of Waters of the State that results from the harvest operation.

For information on obtaining this required certification, contact the DNR-FS (Appendix D.3).

### **Delegation of Inspection and Enforcement Authority**

The State of Maryland offers jurisdictions the ability to enforce these laws and regulations within its own system. This is referred to as “delegation of enforcement authority.” Some jurisdictions have increased the requirements contained in the Standard Plan in order to address local erosion and sediment control concerns. The requirements of a particular county can be determined by contacting the SCD office for that county (Appendix D.1) or the local DNR Project Forester (Appendix D.3). Unless a county has received delegation of enforcement authority, MDE has the responsibility to ensure these requirements are met.

---

<sup>4</sup> COMAR 26.17.01.07.B (6) (f).

## **Plan Certification by a Professional**

Although most Custom Plans are developed and submitted by a LPF, COMAR 26.17.01.07.C<sup>5</sup> states:

“The approval authority may require erosion and sediment control plans receive certification by a professional engineer, land surveyor, landscape architect, architect, or forester (for a forest harvest operation only) that they have been designed in accordance with appropriate approved erosion and sediment control ordinances, regulations, standards, and criteria.”

The LPF’s authority to certify plans is limited to erosion and sediment control plans for forest harvest operations. All Custom Plans are subject to this certification requirement. (Standard Plans are pre-approved and, therefore, are not subject to certification.) A SCD has the option to require certification of a Custom Plan by a professional engineer or other professional if the SCD determines that site conditions warrant it. This can take the form of certification for the entire plan or for a specific measure.

After a SCD has required plan certification (or specific measure certification), the applicant chooses the person who will make the certification. The SCD will accept the selection of the certifier but may continue to challenge the adequacy of the plan or measure.

## **Landowner Responsibility**

When a harvest is planned on private property, it is necessary to go to the local SCD office to obtain the Standard Plan or have a Custom Plan approved. Harvests on State and federal lands require plan approval by MDE. A provision of the plan requires that the landowner agrees to follow the erosion and sediment control requirements by signing the application. Assistance in preparing plans may be obtained from the DNR-FS offices<sup>6</sup>.

---

<sup>5</sup> COMAR 26.17.01.07.C, Title 26, Department of the Environment, Subtitle 17, Water Management, Chapter 01 Erosion and Sediment Control, Regulation 07 Application for Approval of Erosion and Sediment Control Plans, Section C.

<sup>6</sup> See Appendix B to view the Standard Plan content and examples of Standard and Custom Plans that are based on actual plans that have been reviewed and approved.



## WETLAND CONSIDERATIONS

### Nontidal Wetlands

The Maryland Nontidal Wetlands Protection Act and Regulations require the use of BMPs when logging in *Nontidal Wetlands* (NTW). A Custom Plan is required for forest harvest operations in NTW. When filing a Custom Plan for a forest harvest operation in NTW, BMPs (e.g., mats) must be included that will protect the wetland hydrology. The use of these BMPs is required in areas where soil conditions (saturated or inundated) are unable to support logging equipment without compacting or rutting the soil to the point of affecting the soil hydrology.

An applicant or a consultant must determine the presence of NTW on a site. This may be done by using county soil surveys to identify hydric soils, and consulting the *Nontidal Wetlands Guidance Maps*<sup>7</sup> and aerial photographs. When walking the site, clues may include the observance of saturated soil conditions, drainage ways, ponded water, or prevalence of wetland vegetation.

A NTW permit is not required for forestry activities provided the land use remains as forestry. The regulations do require a person conducting forestry activities in NTW to implement BMPs to protect the NTW. As noted above, these BMPs must be incorporated into a Custom Plan prepared by a LPF.

Forestry activities include planting, cultivating, thinning, harvesting, or any other activity undertaken to use the forest resources or to improve their quality or productivity. Activities that change NTW to another land use, including but not limited to agriculture or development, are not forestry activities.

### Procedures for Forestry Activities

A person conducting a forest harvest operation in a NTW shall:

1. Submit to the local SCD or other appropriate plan approval authority a Custom Plan for forest harvest operations prepared by a LPF that includes BMPs that comply with the regulations.
2. Request that the SCD delineate or review and approve the delineation of the extent of the NTW.
3. Comply with the requirements of the approved Custom Plan.

---

<sup>7</sup> Available through Maryland Department of Environment website. Accessed January 5, 2015.  
[http://www.mde.state.md.us/programs/Water/WetlandsandWaterways/DocumentsandInformation/Pages/programs/waterprograms/wetlands\\_waterways/documents\\_information/maps.aspx](http://www.mde.state.md.us/programs/Water/WetlandsandWaterways/DocumentsandInformation/Pages/programs/waterprograms/wetlands_waterways/documents_information/maps.aspx)

## **Best Management Practices**

The NTW regulations state that for forest harvest and regeneration practices, BMPs include but are not limited to:

1. Designing stream crossings to have the shortest distance feasible.
2. Locating roads and log decks to minimize adverse wetland impacts.
3. Harvesting with specialized equipment when NTW soils and hydrology will be adversely affected.
4. Using mats or similar temporary structures to reduce compaction or rutting.

For more detailed information regarding forest harvests in NTW, contact the MDE-WMA, Wetlands and Waterways Program, which issues tidal and nontidal wetland authorizations<sup>8</sup>.

## **Nontidal Wetlands of Special State Concern**

In Maryland, certain wetlands with rare, threatened, or endangered species, or unique habitat receive special attention. MDE is responsible for identifying and regulating these areas that are designated as *Nontidal Wetlands of Special State Concern* (NTWSSC).

Like other NTWs, forest harvests do not require a NTW permit to work in NTWSSC. However, BMPs must be implemented. As part of the BMP strategy within a NTWSSC, a primary protection area must be established, in which no disturbance will occur. When necessary, a secondary protection area must also be established, in which forest management practices are restricted to maintain the integrity of the primary protection area (Appendix H). These protected areas will be delineated by MDE with consultation by the local SCD and DNR's Maryland Natural Heritage Program, taking into consideration the harvesting method and schedule proposed by the landowner and LPF.

## **Chesapeake Bay Critical Area**

The Chesapeake Bay Critical Area is the land within 1,000 feet of the Chesapeake Bay and its tidal waters or tidal wetlands. Timber harvests within the Chesapeake Bay Critical Area, which are 1 acre or more in size and occur within a 1-year interval, are regulated by the Critical Area criteria.

For these projects, a Timber Harvest Plan must be prepared and approved before any timber can be harvested. The approval process is a partnership between a District Forestry Board and the DNR. A Standard or Custom Plan is also required for any harvests that disturb 5,000 square feet or more in the Critical Area.<sup>9</sup>

---

<sup>8</sup> BMPs are further explained in Appendix H. For nontidal wetlands activities and plan review see Appendices H & I. For MDE contacts see Appendix D.2.

<sup>9</sup> The details of the Timber Harvest Plan are explained in Appendix F.2.

## **RELATED ISSUES**

### **Waterway Construction Permits**

The best practice when planning a timber harvest is to avoid crossing any streams or other Waters of the State. Where a crossing is unavoidable, the spanning of the channel with a temporary bridge is recommended. This generally avoids the need for a Waterway Construction Permit and results in the least impact to the stream channel. If a culvert or ford crossing is proposed, a harvesting schedule should include adequate time for obtaining a Waterway Construction Permit.

The General Waterway Construction Permit is a simplified permit application process that may be used for most stream crossings for a forest harvest operation, except those designated as a Wild and Scenic River. Obtaining a Waterway Construction Permit does not negate the requirement for an approved erosion and sediment control plan and may include additional BMPs at the crossing site. Crossings on a Wild and Scenic River require a permit from the DNR<sup>10</sup>.

Temporary construction activities must satisfy the conditions contained in COMAR 26.17.04.10.A and B and 26.17.04.08, as outlined in Appendix G. Information concerning these permits and construction activities may be obtained by calling the Wetlands and Waterways Program of MDE<sup>11</sup>.

### **County Permits**

Some counties also require that a county permit be obtained prior to the harvest. Procedures among the counties for obtaining this type of permit may vary and contact with the local county permitting office is necessary to determine what is needed.

### **Soil Conservation Districts**

The SCD offices are typically the approval authority for forest harvest erosion and sediment control plans. There are 24 separate SCDs in the State. It is likely that there will be some variation in requirements from district to district. This is appropriate because there are extreme differences in the State's physiographic regions, with issues in one part of the State that may not exist in the other parts. It is important to make contact with the specific SCD to determine what special requirements it may have relative to erosion and sediment control plan approval<sup>12</sup>.

---

<sup>10</sup> COMAR 08.15.02.05.

<sup>11</sup> See Appendix D.2.

<sup>12</sup> See Appendix D.1.

## **Invasive Plant Species**

It is desirable to retain native plant species in and around forest harvest sites. There is concern that forest harvest operations may, under certain conditions, facilitate the spread, germination, and establishment of exotic and invasive plant species. For the purposes of this Manual, it is important for the forest product operator, forester, and landowner to be aware of this issue and take responsible actions that can help to control the introduction and spread of exotic and invasive plant species.

It is fortunate that some of the same practices that contribute to sound erosion and sediment control also will contribute to minimizing the potential spread of invasive plant species. These practices include: keeping soil disturbance to the minimum needed to accomplish the harvest; utilizing existing trails and roads; temporary stabilization of disturbed areas; minimizing the period from end of logging to site preparation, revegetation, and contract closure. The DNR-FS can assist with information on measures that can be used to reduce the impact from these species.

## **Forest Conservation Act**

Typically, forest harvest operations are not subject to the provisions of the Forest Conservation Act (FCA), provided a Forestry Declaration of Intent is filed with the County Forestry Board. The applicant needs to verify that this detail is handled during the permitting process. The FCA requirements relate to commercial land development and construction. The information provided here is simply to assist in the event the issue is encountered<sup>13</sup>.

---

<sup>13</sup> Please use the information in Appendix E to obtain more information.

## **FORESTRY BEST MANAGEMENT PRACTICES**

Forestry BMPs are methods or measures used to protect and preserve water quality including, but not limited to, control of water-caused erosion. This Manual is intended to assist foresters, landowners, and timber harvesters with applying erosion control methods, measures, and practices while harvesting and regenerating forests in Maryland.

Water quality problems caused by forestry operations can result from any of the following:

1. Access roads and skid trails associated with timber harvest and delivery.
2. Timber harvesting in progress or recently completed.
3. Site preparation.
4. Logging decks and landings where harvested trees and other forest products are taken for processing, or loading on trucks, barges, or rail cars.
5. Forest fire control.
6. Trash, debris, oils, fluids from equipment and vehicle maintenance.

Forestry BMPs in Maryland encompass seven basic goals in order to protect water quality:

1. Minimize surface runoff, soil erosion, and sedimentation originating from any type of forestry related soil disturbance.
2. Maintain the integrity of all stream beds and banks.
3. Prevent deposition of logging debris in stream beds and channels.
4. Properly locate haul roads and landing areas away from Waters of the State.
5. Establish and maintain SMZs to filter and settle sediment from overland flow.
6. Provide for rapid revegetation of all exposed mineral soil areas through natural processes supplemented by artificial revegetation where necessary.
7. Prevent chemicals, pesticides, fertilizers, and petroleum products from entering or degrading (directly or indirectly) streams, groundwater, and surface water.

## **Forestry Activities – Water Quality Relationships**

In an undisturbed forest, energy is dissipated from raindrops as they hit the ground. Forest litter, organic matter, and roots absorb this energy and prevent soil particles from being detached and transported to streams. The forest floor, with root systems intact and covered by litter and forest debris, is the best protection against erosion and resulting sedimentation. Disturbance of the forest litter layer exposes mineral soil and compaction reduces infiltration. This results in an increased potential for erosion.

The potential for erosion problems arise on logging jobs when logging roads and skid trail systems expose mineral soil, and when residual forest material is removed during site preparation. Under these conditions, rainfall energy is not absorbed by the bare soil. Research indicates that rain falling on scattered small patches of bare soil will not deliver sediment to streams unless these patches form unbroken pathways over long downhill distances. Correct silvicultural practices prevent formation of these unbroken pathways.

Anytime the intended harvest results in a disturbance to the litter covered forest floor and root mat, the natural erosion and sediment control measures are no longer adequate. The logger then is responsible for installing erosion and sediment control practices (structural and/or procedural) to protect Waters of the State from logging site runoff, as called for in the site's Standard or Custom Plan.

On logged forest land, the highest erosion rates are most likely to occur on improperly located and maintained haul roads and skid trails. The expense of establishing a well-designed road system pays off by providing an adequately drained road with moderate grades. Hauling time and the costs of equipment wear and repair are reduced. A well-planned, permanent road system enhances land value by providing easy access for recreation, fire suppression, and forestry and wildlife management activities. By increasing accessibility, the system will lower costs of future timber sales.

## INTRODUCTION TO THE USE OF THE SPECIFICATIONS

The pages that follow contain 20 specifications for BMPs intended for use on forest harvest operations. Five of the specifications (cross-road drainage, general waterway crossing, and temporary bridge, culvert, and ford) are drawn from general construction practices and are broadly applicable to many activities including forest harvest operations. Four more (harvest entrance, straw bale dike, silt fence, and revegetation of disturbed soils) are derived from agricultural and urban erosion and sediment control practices. The remaining 11 specifications are tailored to forest harvest operations.

Regardless of the origin of these 20 specifications, all are well-proven with many years of successful use. When correctly implemented and maintained, they meet the intent of Maryland's erosion and sediment control program and will keep a harvest site in compliance with the approved erosion and sediment control plan.

In order to become comfortable with the use of these specifications, it is necessary to understand how they fit into the overall plan approval process. The LPF selects the specifications that are appropriate for a specific site and the SCD staff confirms these choices during the plan review and approval process.

After the plan is approved, the on-site personnel conducting the harvest use the specifications (as contained on the approved plan) to assist in proper BMP construction and maintenance. The inspection staff (local or State) will use the specifications to ensure proper BMP implementation and maintenance. Both the on-site personnel and the inspector are restricted to what is outlined on the approved plan. If additional BMPs are needed, the LPF and the SCD review staff should become involved again.

The selected specifications contain the established criteria that define how a BMP will be used. These defined criteria guide the use of the BMP by on-site personnel and serve to eliminate the potential (actual or perceived) for arbitrary use of the specifications by the regulatory staff. After a specification is selected by the LPF and approved by the SCD staff, on-site personnel must implement and maintain the site as specified in the conditions of the Standard Plan or an approved Custom Plan.

A sound working relationship between the on-site personnel and the inspector allows time to review the approved plan and to understand the harvest requirements. If a difference of interpretation develops, the specification will, in most cases, clarify the situation.

Each specification is made up of components that allow the on-site personnel to tailor the BMP to a particular harvest site. A specification may contain references to circumstances that are not relevant to a particular site. Knowledge of and experience with the specifications will aid in correctly utilizing the applicable components of a specification as it relates to a specific site. It is the operator's and landowner's obligation to be aware of how a specification must be applied to a site.

The Specifications for Stabilized Harvest Entrance provides an excellent example of how to utilize the specifications:

If the approved plan includes an entrance, the on-site personnel are obligated to implement it. However, the specification allows for options for the selection of material used to construct the entrance, thus allowing on-site personnel to economically utilize material on-hand. The specification offers the choice of an aggregate pad (with an additional choice of stone or recycled concrete), mats (with additional choice of mat material), or wood chips (if acceptable to the SCD). After the type of entrance material is selected, there are requirements related to that choice. For instance, if the aggregate pad is selected, the stone must be 2 to 3 inches in size and laid down 6 inches thick over non-woven geotextile.

The Stabilized Harvest Entrance Specification contains an additional contingency for maintaining existing drainage. Again, knowing how to apply a specification allows the operator to disregard requirements that do not relate to a particular site. Maintenance of existing drainage is a legitimate component of the Stabilized Harvest Entrance Specification; however, if the location of an entrance does not cross a ditch, this aspect of the specification is not required.

Throughout all 20 specifications, there are many such components that are site-specific. Site conditions dictate whether or not a component of a specification is relevant. Given the varying site conditions likely to be encountered, inclusion of a component in a specification is not by itself a sufficient basis for requiring that it be implemented.

**The Specifications that follow fall into three general categories:**

- 1. Planning and Streamside Management Zones**
- 2. Erosion Control of Roads and Trails**
- 3. Revegetation of Disturbed Soils.**

They are presented in that order.



## **Category 1: Planning and Streamside Management Zones**

### **SPECIFICATIONS FOR PRE-HARVEST PLANNING**

#### **Definition**

*Pre-harvest planning* involves collecting information about the area to be harvested. Use of this information can determine the best time for and method used to harvest. An effective pre-harvest plan will take into consideration all aspects of a timber harvest that may lead to water quality degradation and plan for the implementation of BMPs that will minimize the adverse effects of the operation. Elements of pre-harvest planning must consider the need for obtaining all approvals and permits for the project.

#### **Purpose**

This practice provides a plan prior to harvest that identifies an efficient harvest operation and maintains water quality through the use of one or a combination of BMPs.

#### **Condition Where Practice Applies**

This practice applies in all cases where forest products are to be harvested.

#### **Specifications**

The objective of pre-harvest planning is for the forester, landowner/manager, and the logger to determine, based on conditions found on the site to be harvested, which BMPs are necessary to protect water quality and how those BMPs will be implemented. Depending on the site and nature of the harvest, the plan should include any or all of the following: property boundaries, streams and drainages, soil restrictions, slope, environmental concerns, approximation of main haul road and skid trail locations, potential log landings, portable sawmill locations, stream or drainage crossings, and SMZs. Timing of harvest and timber sale contract specifications should be included.

A walk through the harvest area with a topographic map will provide greater insight to existing ground conditions. A site review will aid with determining potential road location, log landings, streams, and wet areas. Assistance can be obtained with site review and contract provisions from the DNR-FS.

In some situations, such as existing roads adjacent to streams, the best practice to control sedimentation may not be covered by the standard practices in this Manual. In this case, a pre-harvest plan is to be discussed with a LPF, and an alternative erosion control strategy developed and approved prior to harvest.

# **SPECIFICATIONS FOR THE SOIL EROSION AND SEDIMENT CONTROL PLAN FOR FOREST HARVEST OPERATIONS IN MARYLAND (STANDARD PLAN)**

## **Definition**

A *Standard Plan* is an erosion and sediment control plan with a pre-approved set of criteria, authorized by COMAR 26.17.01.07.D, for minor grading and earth disturbances, including many timber harvesting operations.

## **Conditions Where Practice Applies**

The Standard Plan may be used for forest harvest operations when ALL of the following conditions are met:

- Road cuts/fills are 3 feet or less (5 feet in Garrett, Allegany, Washington, and Frederick counties).
- Grades for haul roads do not exceed 15 percent.
- Landings are located on slopes 10 percent or less.
- Grades for skid trails do not exceed 20 percent.
- The site has no stream crossings.

If the above conditions or any other criteria of the Standard Plan cannot be met, a Custom Plan, based on the specifications in this Manual, must be developed and submitted to the SCD for approval. If harvesting is proposed within a SMZ, a SMZ Plan must accompany the Standard Plan.

## **Plan Requirements**

1. Unless one operator assumes full responsibility for implementing an approved plan, all forest harvest operators working at a site must obtain an erosion and sediment control plan. An operator is defined as any individual or company that has contracted or subcontracted a portion of the harvest operation. This also applies to those operators conducting firewood cutting or separate forest harvest operations in conjunction with or subsequent to the initial harvest. Each operator must implement and maintain the required practices.
2. The applicant shall notify the appropriate inspection agency (generally either MDE or the county) at least three (3) business days prior to commencing forest harvest operations. The inspection agency must also be notified at least two (2) business days prior to the completion of work.
3. A copy of the approved plan and any applicable SMZ Plan(s) shall be available on site during

harvest operations.

4. Each site may be inspected periodically by local government and/or State inspectors for compliance with the approved plan. State and local inspectors may require field modifications or a plan revision as conditions dictate, to prevent movement of sediment from the site. Plan revisions require approval by the SCD.
5. Failure to properly implement or maintain the practices required by an approved plan, or to comply with written requirements for corrective action, may result in the operation being stopped (issuance of a Stop Work Order) until the deficiencies have been corrected. Failure to take required corrective action may also result in legal action.
6. All erosion and sediment controls must be implemented in accordance with specifications contained in this Manual.
7. The issuance of an approval by the MDE, a SCD, or a jurisdiction not within a SCD, does not relieve the applicant of the continuing responsibility to effectively abate sediment pollution, and to comply with all other applicable local and State laws.

## **Standard Plan Specifications**

### **A. Site Maps:**

1. Site maps or sketches must be prepared for all harvests and submitted with the plan application for approval. The map or sketch must identify the site location and provide directions and distances from the nearest major road intersection.
2. All access points, landings, haul roads, Waters of the State, SMZs, and existing stream crossings must be identified on the map or sketch.
3. If harvesting is planned in a SMZ, a more detailed map of the SMZ areas is required. Additionally, a SMZ Plan must accompany the Standard Plan. The harvest area should also be delineated on a photocopy of the United States Geological Survey 7.5 Minute Series (Topographic) quadrangle maps (USGS maps).

### **B. Site Access:**

1. Access points to the site shall be stabilized with wood chips, corduroy mats, stone aggregate pad, or other methods as shown in the Specifications for Stabilized Harvest Entrance. Any soil or debris that is tracked onto adjoining off-site roads shall be removed and deposited in a controlled area immediately.
2. A grading or entrance permit may be required for a new entrance onto a county or State road. Details may be obtained from the local permitting agency or the State Highway Administration.

3. Existing public road drainage shall not be blocked or damaged by access construction. Pipe culverts or a bridge shall be installed if necessary to maintain existing drainage.

C. Waterway Protection:

1. Any required SMZ shall be marked and properly maintained. (See Specifications for Streamside Management Zone section.)
2. The minimum SMZ width is 50 feet on land with no slope. Where sloping land is encountered, the following formula shall be applied:

$$50 \text{ ft.} + (2 \text{ ft.} \times \% \text{ slope}) = \text{SMZ width (to a maximum of 150 ft.)}$$

*Example for 20% Slope:* 50 ft. + (2 ft. x 20 %) = 50 ft. + 40 ft. = 90 ft. SMZ

**Table 2 – SMZ Width vs. Site Slope**

Slope %	Width of SMZ (ft.) on each side of watercourse
0	50
5	60
10	70
15	80
20	90

3. Unless part of an approved SMZ Plan, new roads, trails, and harvesting equipment are not allowed in any SMZ except to provide access to authorized stream crossings.
4. Harvesting within the SMZ is not allowed unless a SMZ Plan, along with the Standard Plan, is submitted to and approved by the SCD. The SMZ Plan must be prepared by a LPF and include the harvest method, the square footage of basal area to be removed and retained, provisions for removing and restocking the cut trees, and other criteria for the harvest operation<sup>14</sup>.
5. Although not all Waters of the State require the establishment of an SMZ, protecting water quality when harvesting within or near these areas is still required. At a minimum, the following criteria must be adhered to when a SMZ Plan is not required:
  - a. Locating log decks and landing at least 50 feet from any Waters of the State.

---

<sup>14</sup> See Specifications for Streamside Management Zone section for more information about the requirements of an SMZ Plan.

- b. Locating truck haul roads at least 50 feet from any Waters of the State.
- c. Limiting skidding operations to single-pass trails within 50 feet of any Waters of the State.
- d. Fell trees away from Waters of the State and remove any slash that enters Waters of the State.
- e. Avoid crossing Waters of the State. When crossing is unavoidable, required permits must be obtained<sup>15</sup>.
- f. Stabilize within three (3) days any disturbed areas (damage to the humus layer) within 50 feet of Waters of the State unless other sediment control practices have been installed.

#### D. Haul Roads and Skid Trails:

1. Grading of existing roads and/or trails will be limited to that necessary to make them operable, provided that the requirements of Section D (2) and (5) below are met. If any of the conditions cannot be met, an approved Custom Plan will be required in order to utilize the existing roads and/or trails.
2. Haul roads and skid trails shall be laid out along natural land contours to avoid excessive cuts, fills, and grades. No road cut or fill shall exceed 3 feet (5 feet in Garrett, Allegany, Washington, and Frederick Counties). All new roads must be sketched on the plan map and must be flagged in advance of the harvest.
3. Drainage structures shall be provided at the time of construction of haul roads and skid trails according to requirements contained in this Manual.
4. Crossing of perennial or intermittent streams should be avoided. Where it becomes necessary to cross either a perennial or an intermittent stream, a bridge, culvert, or ford crossing shall be temporarily installed. A MDE-WMA Waterway Construction Permit may be required prior to crossing any stream<sup>16</sup>.
5. Grades for haul roads shall not exceed 15 percent. Grades for skid trails shall not exceed 20 percent. If it is not feasible to maintain these grade limits, a Custom Plan that identifies the controls required to prevent erosion, must be approved by the SCD prior to road or trail construction.
6. No haul roads or skid trails other than those providing access to waterway crossings shall be constructed within the SMZ, unless a SMZ Plan has been prepared and approved. Drainage from approaches to waterway crossings shall be diverted to undisturbed areas.

---

<sup>15</sup> See Appendix G.

<sup>16</sup> See Appendix G.

#### E. Landings and Log Decks:

Landings shall be located outside of the SMZ and at least 50 feet from any Waters of the State. Landings shall be located on reasonably level (between 3 and 10 percent slope), well-drained ground. If harvest sites do not have any area with a slope of at least 3 percent, landings shall be located on the maximum slope of the site. Landings located on slopes exceeding 10 percent must be shown on an approved Custom Plan.

#### F. Stabilization:

1. Following completion of installation of all perimeter erosion and sediment controls, and all cut and fill slopes steeper than 3:1 (H:V), stabilization must be accomplished within three (3) calendar days.
2. Within seven (7) days of completion of the harvest, all roads, trails, and landings located on slopes 10 percent or greater shall be graded or backdragged, and seeded and mulched according to specifications. The surface of roads, landings, and trails less than 10 percent shall be graded or backdragged and left in a condition that permits successful natural regeneration of trees, shrubs, or other annual and perennial plants. Under certain circumstances, stabilization of these roads and landings with seed and mulch shall be required.
3. Temporary stabilization may be required to minimize the potential for erosion or if a forest harvest is halted prior to completion. In addition to the practices noted in item 2 above, mats, woods chips, and compacted wood slash may be used as temporary stabilization practices.

#### G. Maintenance:

1. All practices installed shall be maintained at all times to function as intended.
2. Any practice that fails to function properly will be repaired or corrected immediately.

**Diagram 1.0**

**APPLICATION – STANDARD EROSION AND SEDIMENT CONTROL PLAN FOR FOREST HARVEST OPERATIONS**

**I. Site Information**

A. Location: \_\_\_\_\_  
(Include Sketch or Map of Property)

B. Nature of Operation: \_\_\_\_\_ Acres harvested: \_\_\_\_\_  
(Logging including clearcut & damage select cut, Woodchipping, Firewood)

**II. Landowner and Operator Information**

Landowner: \_\_\_\_\_

Address: \_\_\_\_\_

Phone: \_\_\_\_\_ Email: \_\_\_\_\_

Operator: \_\_\_\_\_

Address: \_\_\_\_\_

Phone: \_\_\_\_\_ Email: \_\_\_\_\_

Current F.P.O. Lic. #: \_\_\_\_\_ Green card#: \_\_\_\_\_

1. List the names of other operators who may be involved in the harvest and the nature of their operations: \_\_\_\_\_

2. If subcontracting to any of the operators listed above, do you assume responsibility for their compliance with this plan? \_\_\_\_\_ If no, they must obtain a separate plan prior to their operations.

**III. Agreement**

A. I / We agree to adhere to Standard Erosion and Sediment Control Plan for Forest Harvest Operations, and to grant inspectors the right of entry to the site to monitor compliance.

B. I am aware of the landowner's responsibility in preventing accelerated erosion and sedimentation during and subsequent to forest harvest operations as mandated by the rules and regulations adopted by the State of Maryland and local jurisdictions, and the *2015 Maryland Soil Erosion and Sediment Control Standards and Specifications for Forest Harvest Operations*.

C. I agree to require that all operators conducting forest harvest operations on my property to adhere to the requirements of the Standard Plan.

Landowner: \_\_\_\_\_ Date: \_\_\_\_\_

Operator: \_\_\_\_\_ Date: \_\_\_\_\_

Approved: \_\_\_\_\_ Date: \_\_\_\_\_  
Soil Conservation District

## SPECIFICATIONS FOR STREAMSIDE MANAGEMENT ZONE (SMZ)

### Definition

A *Streamside Management Zone* is a protected area of at least 50 feet in width along the sides of any blue line stream.

### Purpose

The purpose of the SMZ is to provide a relatively undisturbed zone to trap, settle, and filter out suspended sediments before these particles reach the stream, as well as protect stream bank stability and water quality.

### Conditions Where Practice Applies

This practice applies to all blue line streams throughout Maryland, as defined below. Additionally, the SCD or other appropriate approval agency may require the establishment of a SMZ for the protection of a watercourse not mapped as a blue line, if site conditions warrant.

Blue line streams typically include all perennial streams and intermittent streams. Perennial and intermittent streams are streams whose flow includes a permanent, seasonal, or temporary groundwater component (*i.e.* the base level of the stream is at or below the local water table). Such streams flow for days, weeks, or months after a rainfall, or flow year round. These streams are identified on United States Geological Survey 7.5 Minute Series (Topographic) maps as solid or dotted-dashed blue lines (*i.e.* blue line streams). Any erosion and sediment control plan for a site that includes a blue line stream must provide for a SMZ.

*Ephemeral streams* (those that only flow for a few days after a rainfall) are usually not mapped as blue line streams. Although these, as well as other Waters of the State, may not require the establishment of a SMZ, they must still be protected and must not receive sediment-laden runoff as the result of a forest harvest operation.

Ditches managed by a *Public Drainage Association* (PDA) maintain existing erosion and sediment controls, and therefore, a SMZ does not need to be established. However, all of the requirements for Standard Plan specifications apply.

### Specifications

1. The minimum width of a SMZ is 50 feet. This applies when the adjacent land has no slope. The maximum width of a SMZ is 150 feet (on land with slopes over 50%). When sloped land is encountered, the SMZ width shall be established using the following formula:  
$$50 \text{ feet} + (2 \text{ feet} \times \% \text{ slope})$$



2. No new roads are permitted in the SMZ except to access approved stream crossings. If the only activity in the SMZ is the installation of an approved waterway crossing and its approaches, a SMZ Plan is not required. Existing roads, if serviceable and not creating a pollution problem, may be utilized if identified on the SMZ Plan and approved by the SCD.
3. Skid trails are permitted within the SMZ as part of an approved SMZ Plan as described below. The use of any skid trail within the SMZ must be limited so as to minimize disturbance to the forest humus layer. Skid trails located within 50 feet of a body of water shall be single-pass trails. Repair of damage to the humus layer within the SMZ and stabilization of the SMZ following the harvest shall be in accordance with the requirements set by this Manual<sup>17</sup>.
4. Harvesting activity is permitted in the SMZ if authorized by an approved SMZ Plan that follows the listed criteria:
  - a. The SMZ Plan is prepared by a LPF.
  - b. A sketch showing the location of required erosion and sediment control measures is included.
  - c. Stream crossings are avoided where possible. All crossings shall be shown on the sketch and have an approved Waterway Construction Permit, if required.
  - d. The SMZ Plan must show any road leading to the SMZ and skid trails within the SMZ.
  - e. Damage to the humus layer must be minimized. *Damage* is defined as the impairment of the usefulness of the humus layer in controlling sediment-laden stormwater runoff caused by the harvest operations.
  - f. Damage to the humus layer must be repaired immediately and stabilized. *Repair* is defined as returning the humus layer to pre-harvest conditions.
  - g. Exposed soil within the SMZ, resulting from the harvest operation, will be stabilized with seed and mulch within three (3) days of the disturbance.
  - h. Fertilizer shall not be used within the SMZ.
  - i. Use of logging equipment will be limited, with the use of low ground pressure equipment encouraged.
  - j. SMZ Plans may provide for harvesting within 50 feet of a body of water. Felled timber shall be removed by cable, non-vehicular means, extended reach equipment, or by skidder using a single pass. The use of low ground pressure equipment is strongly encouraged.
  - k. The objective of the SMZ is to maintain an effective vegetated buffer. Therefore,

---

<sup>17</sup> See Specifications for Revegetation of Disturbed Soils.

except in limited circumstances, the basal area must not be reduced below 60 square feet of evenly distributed trees which have 6 inches or greater *diameter breast height* (DBH). However, the SMZ may be clearcut if part of an approved *Forest Management Plan*. The clearcut must also be included on the SMZ Plan prepared by a LPF. When a clearcut is authorized, the SMZ Plan shall require additional erosion and sediment controls be implemented as close to the body of water as practical prior to the start of and maintained during the harvest. Controls may include:

- i. Approved vegetated buffer of a specified width.
  - ii. Earth berm.
  - iii. Straw bale dike.
  - iv. Silt fence.
  - v. Other practices approved by the SCD.
- l. All harvested tree limbs and tops must be removed from the stream to prevent stream blockage. Material originating outside of the SMZ shall not be deposited within the SMZ.
  - m. Individual trees to be cut in the SMZ must be marked at eye level and also near the base of the stump, so that the mark is visible after cutting. This requirement does not apply to approved clearcut operations or approved pine plantation thinning operations.
  - n. The method of harvest to ensure sufficient regeneration must be specified in the SMZ Plan.
  - o. Harvesting restrictions will be implemented during adverse weather conditions.
  - p. Trees must be felled away from the stream banks.
5. Sawmill sites and loading decks shall be located outside the SMZ.
  6. Energy dissipaters, such as riprap at cross-drain culvert outlets or discharge points, shall be installed where needed and shown on the SMZ Plan. Do not block water flow when using these structures.
  7. Additional BMPs for the interception and proper discharge of runoff waters from haul roads and skid trails leading to a SMZ may be required<sup>18</sup>.
  8. Stream crossings shall be constructed in accordance with the specifications provided later in this Manual<sup>19</sup>.
  9. All proposed activities within the SMZ shall not contaminate Waters of the State with sediment or any other pollutant (*e.g.*, equipment fluids).

---

<sup>18</sup> See Specifications for Broad-Based Dip, Rolling Dip, Water Bars, and Cross-Road Drainage.

<sup>19</sup> See Specifications for Temporary Access Waterway Crossings and Appendix G.

A sample SMZ Plan form is provided, immediately following the SMZ diagram in this specification. Other formats may be required by the SCD.

**Diagram 2.0 – Streamside Management Zone**

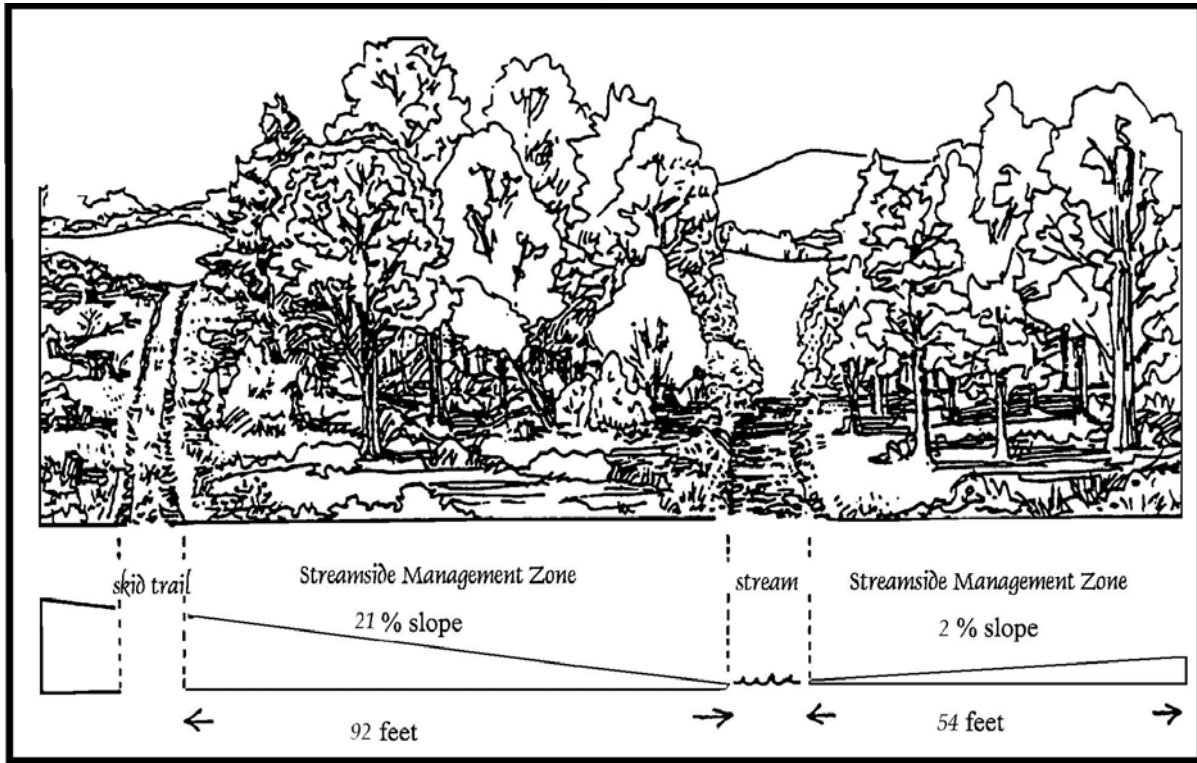

SMZ horizontal width is measured in linear feet from the edge of the pond, lake, or stream bank to the upper limit of the zone.

The SMZ widths shall be maintained during the entire harvest operation. They are determined by the following formula, established by forest researchers for effective SMZ widths:

$$50 \text{ feet} + (2 \text{ feet} \times \% \text{ slope}) = \text{SMZ width (To a maximum of 150 feet)}$$

Examples: (See diagram above)		
21% slope		2% slope
$50 \text{ ft.} + (2 \text{ ft.} \times 21\%) = 50 \text{ ft.} + 42 \text{ ft.} =$ 92 ft. SMZ		$50 \text{ ft.} + (2 \text{ ft.} \times 2\%) = 50 \text{ ft.} + 4 \text{ ft.} =$ 54 ft. SMZ

**SMZ Plan Form**

The form on the following page is an example of one acceptable type plan. Other types are permissible. Check with the SCD.

**Diagram 3.0**

**STREAMSIDE MANAGEMENT ZONE (SMZ) PLAN**

Landowner's Name: \_\_\_\_\_

Address: \_\_\_\_\_

Location: \_\_\_\_\_

*(Attach a map indicating the location of streamside management zone, waterways, planned stream crossings, roads, main skid trails, and landings)*

Area in streamside management zone (SMZ): \_\_\_\_\_ acres.

Width of SMZ (each side of stream): Range (min. – max. width) \_\_\_\_\_ feet;

Average Width: \_\_\_\_\_ feet.

Boundary of SMZ is marked with: \_\_\_\_\_ (color) \_\_\_\_\_ (paint or flagging).

Predominant tree species: \_\_\_\_\_

Current stocking density (basal area): Range (min. – max.): \_\_\_\_\_ sq. ft. / acre;

Average: \_\_\_\_\_ sq. ft./acre.

Average stocking to be retained: \_\_\_\_\_ sq. ft./acre. (Normally > 60 sq. ft. in trees > 6 in. DBH.)

Trees to be harvested are marked with: \_\_\_\_\_ color paint at eye level and on base.

Type of harvest within SMZ: \_\_\_\_\_

*(Thinning, Selection, Shelterwood, Clearcut)*

Regeneration will be from: \_\_\_\_\_

*(Advanced reproduction, Seed, Sprouts, Planted seedlings, or N/A)*

This SMZ Plan is used in conjunction with the Standard Erosion and Sediment Control Plan for this operation. All limitations for harvesting timber within a SMZ, as described in Specifications for Streamside Management Zone (SMZ), of the *2015 Maryland Erosion and Sediment Control Standards and Specifications for Forest Harvest Operations*, will be followed. Additional comments may be attached.

=====

**Prepared by:** \_\_\_\_\_

(MD Licensed Professional Forester) - Printed Name - Signature - Date

**Agreed to by:** \_\_\_\_\_

(Landowner) - Printed Name - Signature - Date

**Approved by:** \_\_\_\_\_

(Soil Conservation Dist.) - Printed Name - Signature - Date

## Category 2: Erosion Control of Roads and Trails

### SPECIFICATIONS FOR STABILIZED HARVEST ENTRANCE

#### Definition

A *stabilized harvest entrance* provides a pad or mat and drainage protection at any point where equipment will be entering or leaving a harvest site onto a public right-of-way.

#### Purpose

This practice reduces tracking of sediment onto roads and public rights-of-way, and protects existing drainage patterns. It also provides a stable area for entrance into or exit from the site.

#### Condition Where Practice Applies

This practice applies any place where access to a forest harvest joins a public right-of-way.

#### Specifications

Each of the following practices provides acceptable stabilized entrances. Select the practice best suited to the particular harvest and availability of materials:

##### Aggregate Pad:

1. Use 2 to 3-inch stone, or reclaimed or recycled concrete, or its equivalent placed to a thickness of at least 6 inches.
2. Non-woven geotextile<sup>20</sup> shall be placed beneath the stone. The use of paper mill felts as underlayment may be substituted with the approval of the SCD.

##### Mats:

1. Corduroy mats made from on-site material of 6-inch minimum diameter.
2. Steel mats designed to support heavy equipment on the existing base.
3. Wooden pads or mats designed to support the equipment on the existing base. These may be constructed by cabling, nailing, or bolting together rough sawn lumber that is at least 2 inches thick<sup>21</sup>.

##### Minimum Size of Stabilized Entrances:

---

<sup>20</sup> See Appendix J.

<sup>21</sup> See Specifications for Logging Mats.

1. Width shall be a 10-foot minimum, and shall be flared at existing road to provide a turning radius for any equipment using the entrance.
2. Length shall be a 50-foot minimum.

**Drainage Protection:**

1. Existing public road drainage shall not be blocked or damaged by access construction.
2. Pipe culverts or a bridge shall be installed if necessary to maintain existing drainage.
3. The drainage pattern shall be restored to its original condition and stabilized upon completion of the harvest.

**Exceptions:**

1. State and local jurisdictions may have requirements that exceed these minimum requirements for entrance to a public road. A grading or entrance permit may be required for a new entrance onto a county or State road. Obtain details from the plan approval or permitting authority.
2. Alternate materials and methods, such as wood chip entrances, may be used if they accomplish the objectives and are approved by the SCD.

**Maintenance**

1. The entrance shall be maintained in a condition that will minimize tracking of sediment onto a public road. This may require periodic additional top dressing of aggregate or other material.
2. All sediment, spilled, dropped, or tracked onto a public right-of-way must be removed immediately and returned to the site.
3. When necessary, truck wheels must be cleaned to remove sediment prior to exiting onto a public right-of-way.

Diagram 4.0 – Stabilized Harvest Entrance

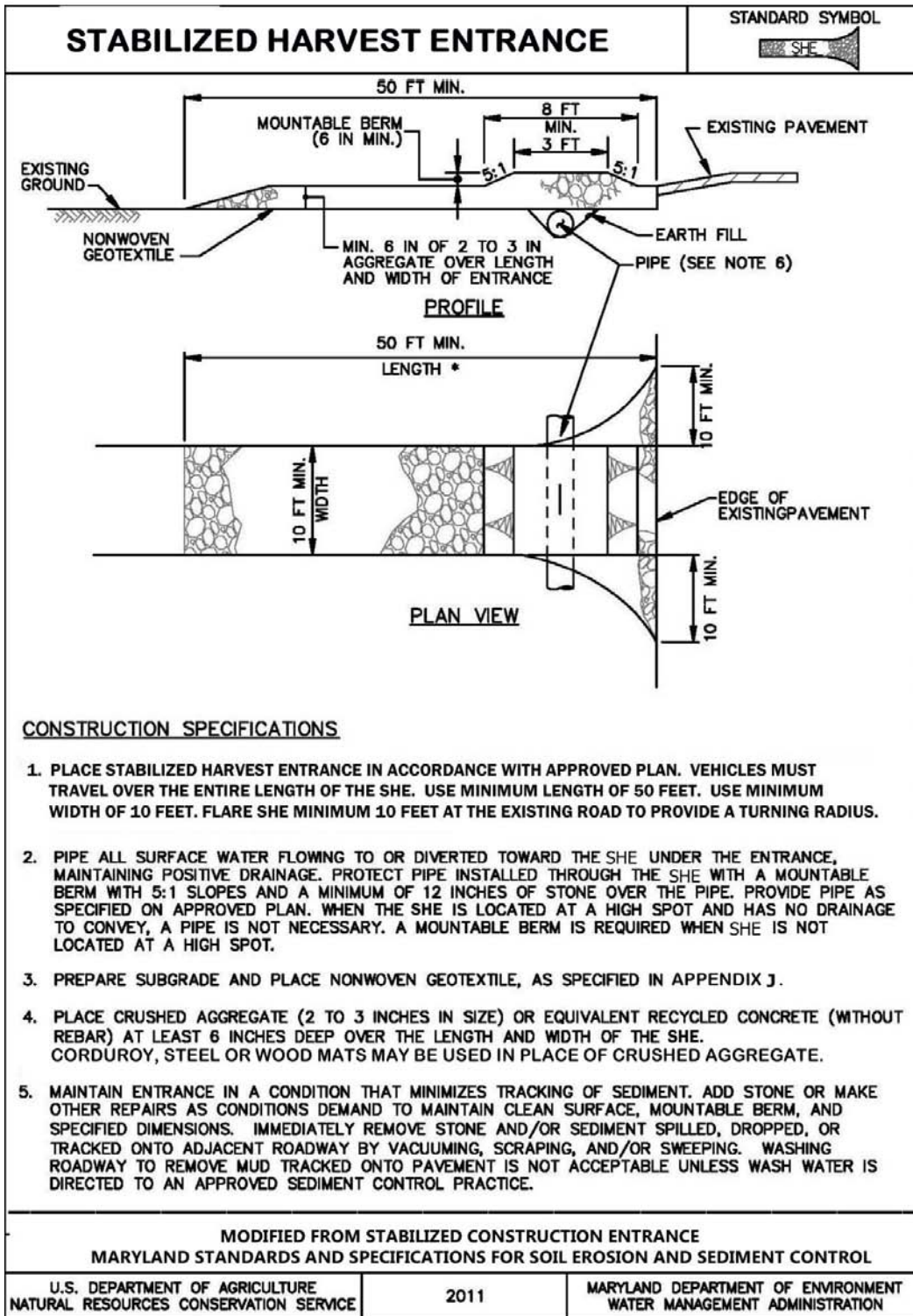



# SPECIFICATIONS FOR TRUCK HAUL ROADS

## Definition

*Truck haul roads* are part of a road system, temporary or permanent, installed for transportation of wood products from the harvest site by truck. Usually they are unsurfaced, single-lane roads with turnouts (wide spots) and installed by grading with a bulldozer or other mechanical equipment where cuts and fills are needed.

## Purpose

An efficient transportation system is necessary to effectively protect the forestland and water quality when removing forest products from the harvest site, developing the forest for recreation, accessing the area for forest fire suppression, or implementing other needed forest management activities. Properly located and constructed roads will provide safety, higher vehicle speeds, and longer operating periods, while reducing operating and maintenance costs.

## Condition Where Practice Applies

This practice applies where the area to be cut and volume per acre makes it necessary and economically feasible for an operator to install a road system.

## Specifications

1. Sound pre-harvest planning helps ensure that the placement of haul roads is on the flattest ground available and avoids the problems associated with road building on extreme slopes. Roads shall follow the contour as much as possible. Normally, grades shall remain between 2 and 15 percent. However, grades are permitted to be as steep as 20 percent for distances not exceeding 200 feet, if approved as part of a Custom Plan. If steeper grades are necessary, practices must be approved and used to prevent concentrated water flow that causes gullies.
2. Water diversion by cross-drainage (interception of surface water on the road) is often needed to keep excess water off the steeper grades<sup>22</sup>.
3. The crossing of intermittent or perennial streams is to be as close to a right angle to the stream as possible, using bridges, culverts, or rock fords. Structures shall be sized and placed so as not to impede fish passage or stream flow<sup>23</sup>.
4. Install water turnouts prior to a stream crossing to direct runoff to undisturbed areas of the

---

<sup>22</sup> See Specifications for Cross-Road Drainage.

<sup>23</sup> See Specifications for Temporary Access Waterway Crossing). Use of fords is only acceptable as described in the Specifications for Temporary Access Waterway Crossing – Ford.

SMZ. Road gradients approaching water crossings should be changed to disperse surface water at least 25 feet from the stream. Locate roads outside of the SMZ, with the exception of waterway crossings<sup>24</sup>.

5. Out-slope the entire width of the road where road gradient, soil type, and site conditions will permit. In-slope the road toward the bank as a safety precaution on sharp turns, road gradients of 15 percent, and on clay or slippery soils. Use cross-road drainage on in-sloped or crowned roads to limit travel distance of runoff water.
6. Where roads are in-sloped or crowned, broad-based or rolling dips shall be placed within the first 25 feet of upgrade, if gradients begin to exceed 20 percent for more than 200 feet.
7. Place roads on side slope to avoid level ridge tops. Avoid wet floodplain soils where drainage is difficult to establish.
8. On truck haul roads that intersect main highways, gravel, wooden mats, or other means shall be used to keep mud off the highway<sup>25</sup>.
9. Provide a minimum width of 10 feet for a single-track road. Increase width as necessary at curves and turnouts.
10. Vertical road bank cuts normally are not to exceed 3 feet in height. This restriction on vertical road bank cuts is increased to 5 feet in Garrett, Allegany, Washington, and Frederick counties. Any cuts that exceed these limits require a Custom Plan.
11. Road bank cuts more than 5 feet high must be part of a Custom Plan and are normally sloped to at least a 3:1 ratio, but shall in no case exceed a 2:1 ratio. Cuts must be stabilized within three (3) days to prevent erosion.
12. Good road drainage shall be maintained. Ensure good road drainage with use of properly constructed and spaced turnouts, broad-based dips, rolling dips, or culverts. Turnouts will be constructed so water will be dispersed and will not cut channels across the SMZ<sup>26</sup>.
13. For cross drains, install riprap or native stone, if suitable, at the outlets of culverts or dips to dissipate velocity and to limit the disturbance.
14. If necessary to ensure that roads dry out, cut trees along the side of the road to allow sunlight to reach the wet surface. This practice is known as *daylighting*.

## **Maintenance**

1. Restrict traffic on roads during wet conditions. Use of wooden mats and gravel may allow operations during wet soil conditions. Haul only during dry weather on wet soils, erodible soils, or road gradients exceeding 10 percent that do not have erosion protection.

---

<sup>24</sup> See Specifications for SMZ.

<sup>25</sup> See Specifications for Stabilized Harvest Entrance.

<sup>26</sup> See Specifications for Water Turnouts.

2. Keep roads free of obstructions, ruts, and logging debris to allow free flow of water from road surface.
3. Control the flow of water on the road surface by keeping drainage systems open at all times during logging operations.
4. Inspect the road at regular time intervals to detect and correct maintenance problems.
5. When all silvicultural activities are completed, re-shape the roadbed to ensure that drainage systems are open.
6. Upon completion of the operation, depending upon slope, all haul roads with exposed soil must, within seven (7) days, either be:
  - a. Graded or backdragged; (if less than 10 percent slope); or
  - b. Graded or backdragged, seeded, and mulched (if more than 10 percent slope)<sup>27</sup>.

---

<sup>27</sup> See Specifications for Revegetation of Disturbed Soils.

## SPECIFICATIONS FOR SKID TRAILS

### Definition

A *skid trail* is an unsurfaced, single-lane trail, or narrow road that is usually narrower and sometimes steeper than a truck haul road.

### Purpose

This practice allows logs, tree lengths, or other roundwood products to be transported from the stump to a common landing or concentration area.

### Conditions Where Practice Applies

This practice is used to bring harvesting products to central locations for sawing or loading on trucks or trailers, and where topography or the size of an operation makes skidding the primary and most economical means of collecting trees, logs, or other roundwood products.

### Specifications

1. Sound pre-harvest planning includes the layout of major skid trails and the location of log landings. This avoids the problems associated with trail building on extreme slopes, minimizes damage to the residual stand, reduces erosion and sedimentation, and provides the most economical method for skidding products.
2. Normally, gradients shall not exceed 20 percent. However, grades are permitted to be as steep as 25 percent for distances not greater than 200 feet, under an approved Custom Plan.
3. If steeper grades are necessary, approved practices must be installed to prevent concentrated water flow that causes erosion.
4. Typically, skid trails are not allowed inside a SMZ. If any equipment will be used in a SMZ (other than for stream crossings with an approved Waterway Construction Permit), a SMZ Plan prepared by a LPF, and approved by the SCD, will be required. Skid trails located within the SMZ shall be utilized so as to minimize disturbance to the humus layer. Skid trails located within 50 feet of a watercourse must be single-pass trails. Repair of damage to humus layer and stabilization shall be in accordance with the requirements set by this Manual<sup>28</sup>.
5. When approaching crossings, cross-drains (culverts or dips) should be used to move water off the skid trail and protect banks. Use methods such as layers of poles (corduroy) along the approach to provide temporary bank protection.
6. Cross perennial or intermittent streams with bridges or culverts of acceptable design. Use of fords is only acceptable as described in the Specifications for Temporary Stream Crossings.

---

<sup>28</sup> See Specifications for SMZ and Specifications for Revegetation of Disturbed Soils.

Logs shall not be skidded through intermittent or perennial streams. Stream crossings may require a Waterway Construction Permit (Appendix G). Contact MDE-WMA for permitting information (Appendix D.2). Bridges are the preferred method for crossing streams.

7. Approaches to water crossings shall be as near to right angles to the stream direction as possible.
8. Avoid long steep grades; climb upslope on a slant or zigzag pattern.

## **Maintenance**

1. Upon completion of skidding, the areas subject to erosion shall have water bars or other cross drainage structures installed immediately<sup>29</sup>.
2. Any exposed soil resulting from the construction of the skid trail shall be stabilized in accordance with the 3 to 7 day criteria. Any cut and fill slopes steeper than 3:1 and any trails within 50 feet of a property line or body of water must be stabilized within three (3) days<sup>30</sup>.
3. Upon completion of the operation, depending upon slope, all skid trails with exposed soil must, within seven (7) days, either be:
  - a. Graded or backdragged; (if less than 10 percent slope); or
  - b. Graded or backdragged, seeded, and mulched (if more than 10 percent slope)<sup>31</sup>.

---

<sup>29</sup> See Specifications for Water Bars.

<sup>30</sup> See Specifications for Revegetation of Disturbed Soils.

<sup>31</sup> See Specifications for Revegetation of Disturbed Soils.

## SPECIFICATIONS FOR LOG DECKS AND LANDINGS

### Definition

*Decks and landings* are areas where logs are collected at the end of skid trails and beside haul roads.

### Purpose

This practice establishes a centralized location where harvested timber products are collected for sorting and/or loading on trucks.

### Condition Where Practice Applies

This practice applies where the harvest area is large enough to require concentrating materials for loading. Nearly all timber harvest will utilize a log deck or landing.

### Specifications

1. This practice generally results in disturbance of the soil surface. Properly locate decks, landings, and portable mill sites to minimize the chances of erosion or sedimentation.
2. Locate decks and portable mill sites in advance of road construction.
3. Locate portable mills and decks at least 50 feet from the upper limit of any SMZ.
4. Sound pre-harvest planning will allow placement of landings and decks on optimal slopes and avoid the problems associated with building in extreme locations. Decks and landings must be located on reasonably level (3 to 10 percent), well-drained ground. If the site does not have any area with a slope of at least 3 percent, landings will be located on the maximum slope of the site. If grades steeper than 10 percent are necessary, an approved Custom Plan, indicating practices to be used to prevent concentrated water flow is required.
5. Provide for adequate drainage on approach roads and trails so that surface water does not drain onto the deck area and cause ponding.
6. Provide a diversion ditch around the uphill side of decks to intercept the flow of surface water and direct it away from the deck.
7. Locate residue piles (sawdust, slabs, etc.) outside of wet weather drainages so that water from residue will not drain into adjacent streams or bodies of water.

## **Maintenance**

Upon completion of the operation and depending upon slope, all decks and landings with exposed soil must, within seven (7) days, either be:

- a. Graded or backdragged; (if less than 10 percent slope); OR
- b. Graded or backdragged, and seeded and mulched (if more than 10 percent slope)<sup>32</sup>.

---

<sup>32</sup> See Specifications for Revegetation of Disturbed Soils.

## SPECIFICATIONS FOR BROAD-BASED DIP

### Definition

A *broad-based dip* is a dip and reverse slope in a road surface with an outward slope in the dip for natural cross-drainage.

### Purpose

This practice provides cross-drainage on in-sloped truck roads. This prevents buildup of excessive surface runoff and subsequent erosion.

### Conditions Where Practice Applies

This practice applies where truck haul roads and heavily used skid trails have a gradient of 10 percent or less. This practice is not for use for cross-draining spring seeps, or intermittent or perennial streams. Broad-based dips are very effective with gathering surface water and directing it safely off the road. Dips are placed across the road in the direction of water flow. This type of structure allows normal truck speeds without adding stress to the vehicle.

### Specifications

1. Installation takes place following basic clearing and grading for roadbed construction.
2. Begin construction by locating the discharge point, which is usually a low point in the road grade.
3. Compact the area and cover the dip with 3 inches of #2 stone (nominal dimension of 2 inches) for conveyance of stormwater runoff and roadbed protection. The stone is not necessary if the roadbed is composed of shale or bedrock.
4. Place larger stone at the discharge point where water is channeled from the road surface to protect the outfall area.
5. All side-cast material shall be stabilized with seed and mulch within seven (7) days.
6. A 20-foot long, 3 percent reverse grade is constructed into the existing roadbed by cutting from upgrade of the dip location.
7. The cross-drain out-slope will be 3 percent maximum.
8. To reduce water velocity, use an energy dissipater such as riprap; or in most cases, a level area at the outfall of the dip where the water can spread.



9. Spacing of broad-based dips will be determined by the following formula:

$$\text{Spacing (in feet)} = (400 \text{ ft.} \div \text{Slope \%}) + 100 \text{ ft.}$$

*For example:*  $(400 \text{ ft.} \div 8\%) + 100 \text{ ft.} = 50 \text{ ft.} + 100 \text{ ft.} = 150 \text{ ft.}$  apart

**Table 3 – Broad-Based Dip Spacing vs. Road Grade**

Slope %	Spacing Between Dips (feet)
2	300
3	235
4	200
5	180
6	165
7	155
8	150
9	145
10	140

10. An inherent problem with construction of a broad-based dip is recognizing that the roadbed consists of two planes rather than one unbroken plane. One plane is the 20-foot reverse grade toward the uphill road portion and outlet. The other plane is the grade from the top of a hump or start of a downgrade to the outlet of the dip. Neither the dip nor the hump is to have a sharp, angular break, but is to be rounded to allow a smooth flow of traffic. These dips do not damage loaded trucks at slow vehicle speed. Dips require minimal annual maintenance and continue to function years after abandonment. Only the dip is out-sloped to provide sufficient break in grade to turn the water.

Diagram 5.0 – Broad-Based Dip

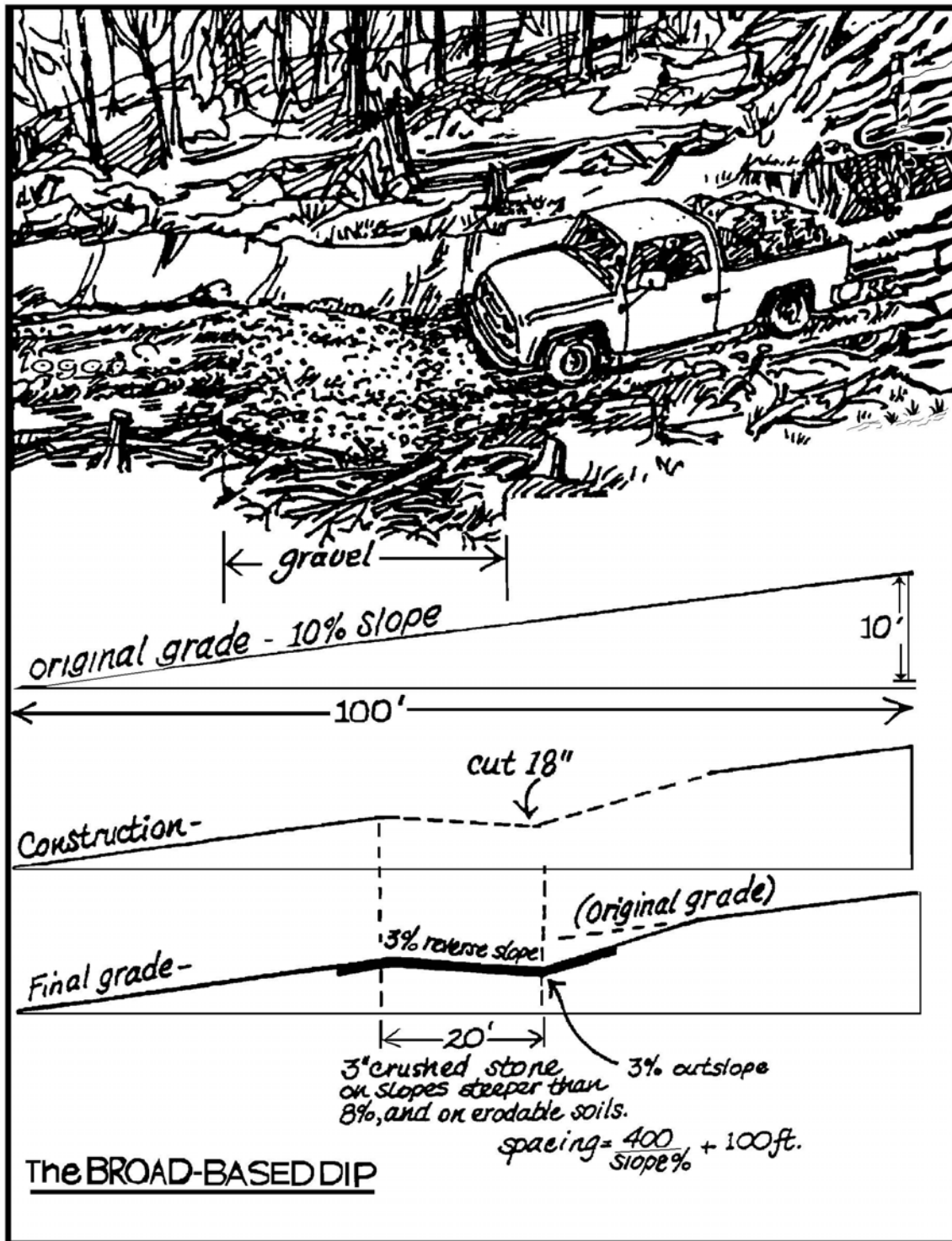

## SPECIFICATIONS FOR ROLLING DIP

### Definition

A *rolling dip* is a dip and reverse slope in a road surface with an out-slope in the dip for natural cross-drainage. This structure is to be used on roads that are too steep for broad-based dips.

### Purpose

This practice provides cross-drainage on in-sloped truck roads. This prevents excessive surface runoff and subsequent erosion.

### Conditions Where Practice Applies

This practice applies where truck haul roads and heavily used skid trails have a gradient of 15 percent or less. This practice is not for use for cross-draining spring seeps, or intermittent or perennial streams.

### Specifications

1. Installation takes place following basic clearing and grading for roadbed construction on skid trails.
2. A 10-foot to 15-foot long, 3 to 8 percent reverse grade is constructed into the existing roadbed by cutting from upgrade to the dip location and using cut material to build up the mound for the reverse grade.
3. Spacing of rolling dips will be determined by the following formula:

$$\text{Spacing (in feet)} = (400 \text{ ft.} \div \text{Slope \%}) + 100 \text{ ft.}$$

***For example:***  $(400 \text{ ft.} \div 8\%) + 100 \text{ ft.} = 50 \text{ ft.} + 100 \text{ ft.} = 150 \text{ ft.}$  apart

**Table 4 – Rolling Dip Spacing vs. Road Grade**

Slope %	Distance Between Rolling Dips (Feet)
2 - 5	300 - 180
5 - 10	180 - 140
10 - <15	140- 125
15 +	120

**Diagram 6.0  
Rolling Dip**

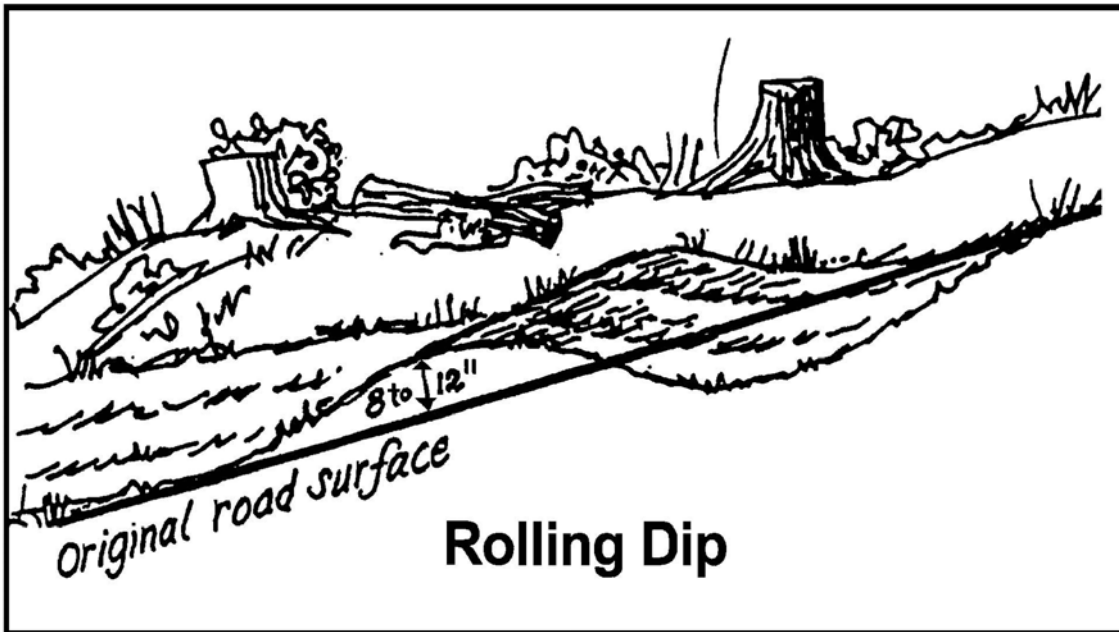

## SPECIFICATIONS FOR WATER BARS

### Definition

A *water bar* is a post-harvest trench and berm constructed across a road or trail. On sandy soils, the trench is usually reinforced with a pole. This structure is also called a *water break*.

### Purpose

This is a post-harvest practice. It is used to intercept and divert side-ditch and surface runoff from roads or trails that will not have vehicular traffic. This practice is used to minimize erosion and provide conditions suitable for natural or artificial revegetation.

### Conditions Where Practice Applies

This is a practice for use on road or trail grades where surface water runoff causes erosion of the exposed soil. Use only where there will not be any vehicular traffic. If there is a potential for vehicular traffic, use rolling dips.

### Specifications

1. Determine proper spacing between water bars using the following formula:

$$1000 \div (\text{Slope \%} + 2.5) = \text{water bar spacing}$$

**Table 5 – Water Bar Spacing vs. Road Grade**

Slope %	Distance between Water Bars (feet)
2	230
5	135
10	80
15	60
20+	45

2. Water bars are to be at an angle of 30 to 45 degrees downslope to turn surface water off the road or trail.

3. Excavate a trench 3 to 4 inches below the surface of the road or trail with an 8 to 12-inch berm on the downhill side of the trench. Use spoil materials to develop the bar height.
4. The uphill end of the bar shall extend beyond the side-ditch line of the road and tie into the bank to fully intercept any ditch flows.
5. The outflow end of the bar is to be fully opened and extend far enough beyond the edge of the road or trail to safely disperse runoff water onto the undisturbed forest floor.
6. On sandy soils, a 5 to 8-inch diameter pole shall be placed in the full length of the trench. This pole shall be pegged and covered with soil on the downslope side.
7. Ensure that the outlet is open and consider the need for energy-dissipating water spreaders at or below drain outlet on sensitive areas.

### **Maintenance**

Upon completion of the operation, exposed soil resulting from the creation of water bars must be seeded and mulched in accordance with the stabilization requirements for a haul road or skid trail<sup>33</sup>.

---

<sup>33</sup> See Specifications for Revegetation of Disturbed Soils.

Diagram 7.0  
Water Bars

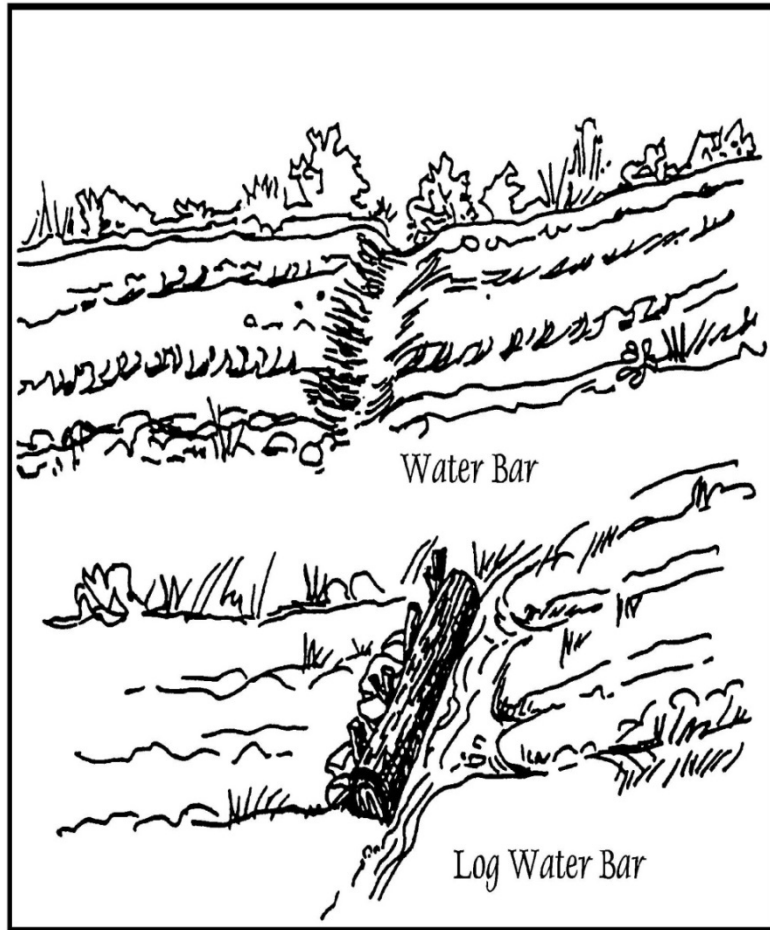

## SPECIFICATIONS FOR WATER TURNOUTS

### Definition

A *water turnout*, or *diversion ditch*, is a structure installed to move water away from the road and/or side ditch.

### Purpose

This practice collects and directs road surface runoff from one side of the road away from the road and into undisturbed areas.

### Conditions Where Practice Applies

This practice applies to any sloping road or trail section where water could accumulate. The practice diverts the water into undisturbed areas so the volume and velocity are reduced on slopes.

### Specifications

1. A buildup of drainage water in roadside ditches can erode roadbeds, scour the road ditch itself, and transport soil particles downslope. Water turnouts channel the water away from these roadside ditches and disperse it into areas adjacent to the road.
2. The turnout shall intersect the ditch line at an equal depth and be out-sloped 1 to 3 percent.
3. On sloping roads, the turnout shall be 30 to 45 degrees downslope.
4. Turnouts shall be spaced to allow the roadbed to dry out and reduce the volume and velocity of side ditch waters.
5. Runoff water shall spread at the outlet of the turnout.
6. Turnouts shall not feed directly into adjacent drainage ways or channels.
7. Turnouts can be constructed of brush dams, earth dams, or flat spreader gaps.



Diagram 8.0  
Water Turnouts

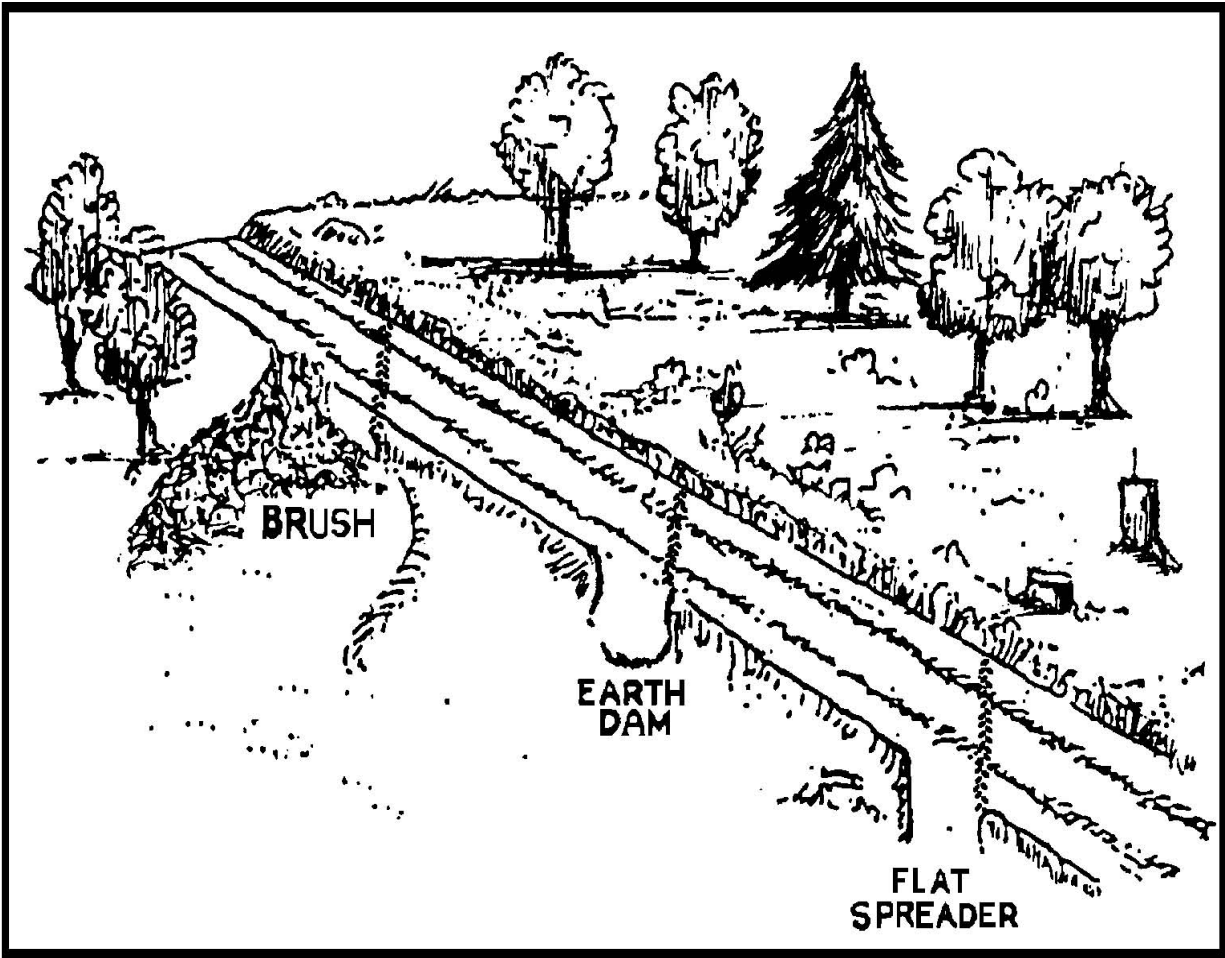

## SPECIFICATIONS FOR CROSS-ROAD DRAINAGE

### Definition

*Cross-road drainage* is a structure that consists of corrugated metal pipe, wooden open top box culvert, or other suitable material that is installed under truck haul roads or major skid trails to convey stormwater runoff and seeps from the roadside ditch to the adjacent forest floor.

### Purpose

This practice collects and transmits water flow safely from side ditches or seeps under haul roads and skid trails, without eroding drainage systems or road surfaces. These structures are to be used to control stormwater only and normally will be dry<sup>34</sup>.

### Conditions Where Practice Applies

Use culverts for any size operation where cross-drainage of stormwater is needed for truck haul roads or major skid trails. In some cases, a temporary culvert is necessary for drainage crossing a smaller skid trail. Inspect permanent installations for obstructions prior to the close of a timber sale.

### Specifications

#### Pipe Culverts:

1. Pipe length shall be long enough so both ends extend at least 1 foot beyond the side slope of fill material.
2. A culvert shall be placed on a 2 to 4 percent grade to prevent clogging.
3. Installation shall be skewed 30 to 45 degrees downgrade.
4. Where erosion may occur, either upstream or downstream of the culvert, erosion protection shall be provided. This protection generally will be in the form of riprap or soil stabilization matting.
5. Culverts shall be firmly anchored and earth compacted at least halfway up the side of the pipe to prevent water from leaking around it. A minimum of half the culvert diameter (but not less than 1 foot) of fill shall be placed above the culvert. Erosion protection measures shall be employed on any earthen fill.

---

<sup>34</sup> If working with stream flows, see Specifications for Temporary Access Waterway Crossings.

### Open Top Box Culvert:

1. Open top box culverts shall not be used for handling intermittent or live streams, or skid trail cross-drainage.
2. Box culvert shall be installed flush or just below road surface, and skewed at an angle of 30 to 45 degrees downgrade.
3. The upper end of the culvert shall be at grade with the side ditch and the lower side extended into the toe of upslope bank.
4. The outfall shall extend beyond the road surface with adequate riprap or other material to dissipate water velocity and to ensure no erosion of fill material.
5. Cleanout maintenance is necessary to remove sediments, gravel, and logging debris, and allow normal flow of runoff water through the structure at all times.

### Cross-Road Drainage Spacing:

Determine proper spacing of cross-road drainage structures using the following formula:

$$\text{Spacing} = (400 \text{ ft.} \div \text{Slope \%}) + 100 \text{ ft.}$$

**For example:**  $(400 \text{ ft.} \div 8\%) + 100 \text{ ft.} = 50 \text{ ft.} + 100 \text{ ft.} = 150 \text{ ft.}$  apart

**Table 6 – Cross-Road Drainage vs. Road Grade**

Slope %	Distance between Structures (feet)
2	300
3	235
4	200
5	180
6	165
7	155
8	150
9	145
10	140
12	135

Diagram 9.0  
Pipe Culvert Installation

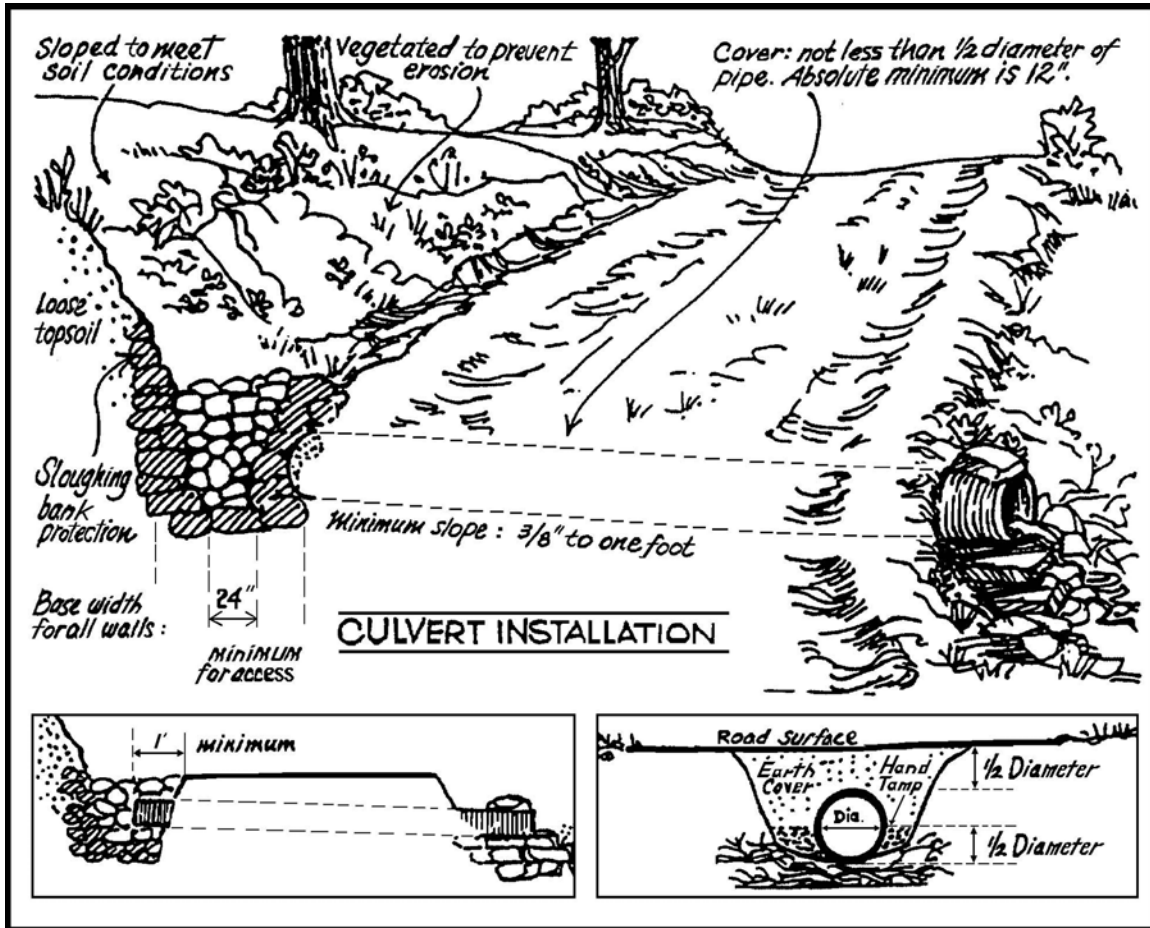
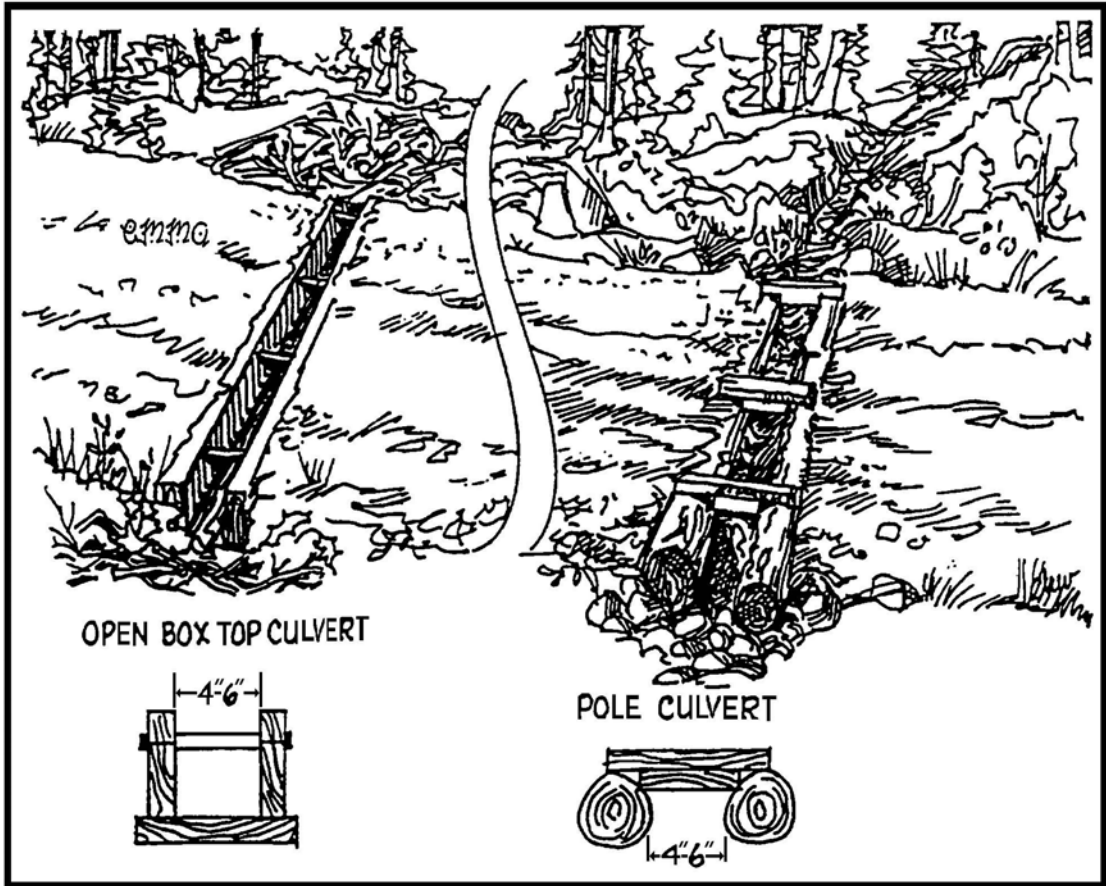

Diagram 9.1  
Open Top Box and Pole Culverts



# **SPECIFICATIONS FOR TEMPORARY ACCESS WATERWAY CROSSINGS – GENERAL REQUIREMENTS**

## **Definitions**

A *temporary access waterway* crossing is a structure placed across a waterway to provide access for harvest purposes for a period of less than one (1) year. Temporary access crossings shall not be utilized to maintain traffic for the general public.

## **Purpose**

The purpose of the temporary access waterway crossing is to provide safe, pollution-free access across a waterway for harvest equipment by establishing minimum specifications for the design, construction, maintenance, and removal of the structure. Temporary access waterway crossings are necessary to prevent equipment from damaging the waterway, blocking fish migration, and tracking sediment and other pollutants into the waterway. Sound pre-harvest planning will allow crossings to be in service for the shortest practical period of time and removed as soon as their function is completed.

## **Condition Where Practice Applies**

The specifications listed below and in the next three sections are general technical requirements for any temporary access waterway crossing. The principle consideration for development of these specifications is concern for soil erosion and sediment control. Structural integrity and safety for the expected loading must also be considered when designing temporary access waterway crossings. Specific requirements included in a MDE-WMA Waterway Construction Permit (required for most culvert and ford crossings) take precedent when they differ from the specifications listed here. See Appendix G for more information about when a Waterway Construction Permit must be obtained. The three types of temporary access waterway crossings are *bridges*, *culverts*, and *fords*.

## **General Specifications**

1. Fish passage must not be obstructed by the installation of a waterway crossing.
2. The construction of any specific crossing practice shall not cause a significant water level difference between the upstream and downstream water surface elevations. The order of preference for use of the individual practices is:
  - a. A bridge is first preference. It should span the entire stream including its floodplain;
  - b. Second preference is the single pipe or pipe bundle culvert; OR
  - c. The least preferred measure is the rock ford.
3. The temporary waterway crossing shall be at right angles to the stream, unless the approach conditions dictate otherwise.

4. The temporary crossing should be located where there will be the least disruption to the soils and terrain of the existing waterway banks and approaches. When possible, locate the crossing at a point receiving minimal runoff.
5. The centerline of both roadway approaches shall coincide with the crossing alignment centerline for a minimum distance of 50 feet from each bank of the waterway being crossed. If physical or right-of-way restraints preclude the 50-foot minimum, a shorter distance may be provided. All fill materials associated with the roadway approach shall be limited to a maximum height of 2 feet above the existing floodplain elevation. To the extent possible, the work on the approaches primarily within the floodplain shall be limited to grading in order to keep the road as close to the existing grades as possible.
6. All approaches and crossings shall have one (1) traffic lane. The minimum width shall be 12 feet, with a maximum width of 20 feet.
7. Runoff on the approaches must be at a non-erosive velocity. This can be attained through surface stabilization or surface runoff diversion. This will prevent roadway surface runoff from directly entering the waterway<sup>35</sup>.

### **Considerations for Choosing a Specific Practice**

1. The physical constraints of the site may preclude the selection of certain standard practices.
2. The time of the year may preclude the selection of certain standard practices due to fish spawning or migration restrictions.
3. Vehicular loads, traffic patterns, and frequency of crossings should be considered in choosing a specific practice.
4. The standard practices will require varying amounts of maintenance. The bridge should require the least maintenance; whereas, the culverts and ford will probably require more intensive maintenance.
5. Installation of a bridge is less likely to require a MDE-WMA Waterway Construction Permit than a culvert or ford crossing.
6. Ease of removal and subsequent damage to the waterway should be primary factors in considering the type of crossing to install. ***Temporary crossings must be removed within 14 calendar days after the crossing is no longer needed, unless a time-of-year restriction is in place.***

---

<sup>35</sup> See Specifications for Water Turnouts.

# SPECIFICATIONS FOR TEMPORARY ACCESS WATERWAY CROSSINGS – BRIDGE

## Definition

A *temporary access bridge* is a structure made of wood, metal, or other materials that provides access across an intermittent or perennial stream.

## Considerations

1. ***This is the preferred practice for temporary access waterway crossings.*** Normally, bridge construction causes the least disturbance to the waterway bed and banks, when compared with the other access waterway crossings. Disturbance to the stream banks shall be kept to a minimum.
2. Most bridges can be quickly removed and reused.
3. Temporary access bridges pose the least chance for interference with fish migration and may eliminate the need for additional permits.

## Specifications

1. Construction, use, or removal of a temporary access bridge will not normally have any time-of-year restrictions because construction, use, or removal should not affect the stream or its banks unless built with piers(s) in the water.
2. A temporary bridge structure shall be constructed at or above the bank elevation to prevent trapping floating materials and debris.
3. Abutments shall be placed parallel to and on stable banks.
4. Bridges shall be constructed to span the entire channel. If the channel width exceeds 8 feet, as measured from top-of-bank to top-of-bank, then a footing, pier, or bridge support may be constructed within the waterway if any required Waterway Construction Permit has been obtained. One additional footing, pier, or bridge support will be permitted for each additional 8-foot width of the channel. However, no footing, pier, or bridge support will be permitted within the channel for waterways less than 8 feet wide.
5. Stringers shall be logs, sawn timber, pre-stressed concrete beams, metal beams, or other approved materials.
6. Decking materials shall be of sufficient strength to support the anticipated load. All decking members shall be placed perpendicular to the stringers, butted tightly, and securely fastened to the stringers. Decking materials must be butted tightly to prevent any soil material that has been tracked onto the bridge from falling into the waterway.
7. Run-planking (optional) shall be securely fastened to the length of the span. One (1) run-plank shall be provided for each track of the equipment wheels. Although run-planks are optional, they may be necessary to properly distribute loads.



8. Curbs or fenders, made from sawn timber, logs, or other approved material shall be installed along the outer sides of the deck to prevent tracked sediments from falling over the edge of the bridge, and to provide additional safety during transits.
9. Bridges shall be securely anchored at only one (1) end using steel cable or chain. Anchoring at only one (1) end will prevent channel obstruction in the event that floodwaters float the bridge. Acceptable anchors are large trees, large boulders, or driven steel anchors. Anchoring shall be sufficient to prevent the bridge from floating downstream and possibly causing an obstruction to the flow.
10. All areas disturbed during installation shall be stabilized within 24 hours. Approaches to the bridge should be stabilized and kept free of erosion<sup>36</sup>.

## **Maintenance**

1. Periodic inspection shall be performed by the user to ensure that the bridge, streambed, and stream banks are maintained and not damaged. Decking and curbs should be kept tightly butted without gaps.
2. Maintenance shall be performed as needed to ensure that the structure complies with these specifications. This shall include daily removal and disposal of any tracked sediment or trapped debris. Sediment shall be disposed of outside of the floodplain and stabilized.

## **Bridge Removal and Cleanup Requirements**

1. When the temporary bridge is no longer needed, all structures including abutments and other bridging materials shall be *removed within 14 calendar days*.
2. Final cleanup shall consist of removal of the temporary bridge from the waterway, protection of banks from erosion, and removal of all construction materials. All removed materials shall be stored outside the waterway floodplain.
3. Removal of the bridge and cleanup of the area shall be accomplished without construction equipment working in the waterway channel.
4. All areas disturbed during removal shall be *stabilized within 24 hours*.

---

<sup>36</sup> See Specifications for Revegetation of Disturbed Soils.

**Diagram 10.0**  
**Temporary Access Waterway Crossing – Bridge**

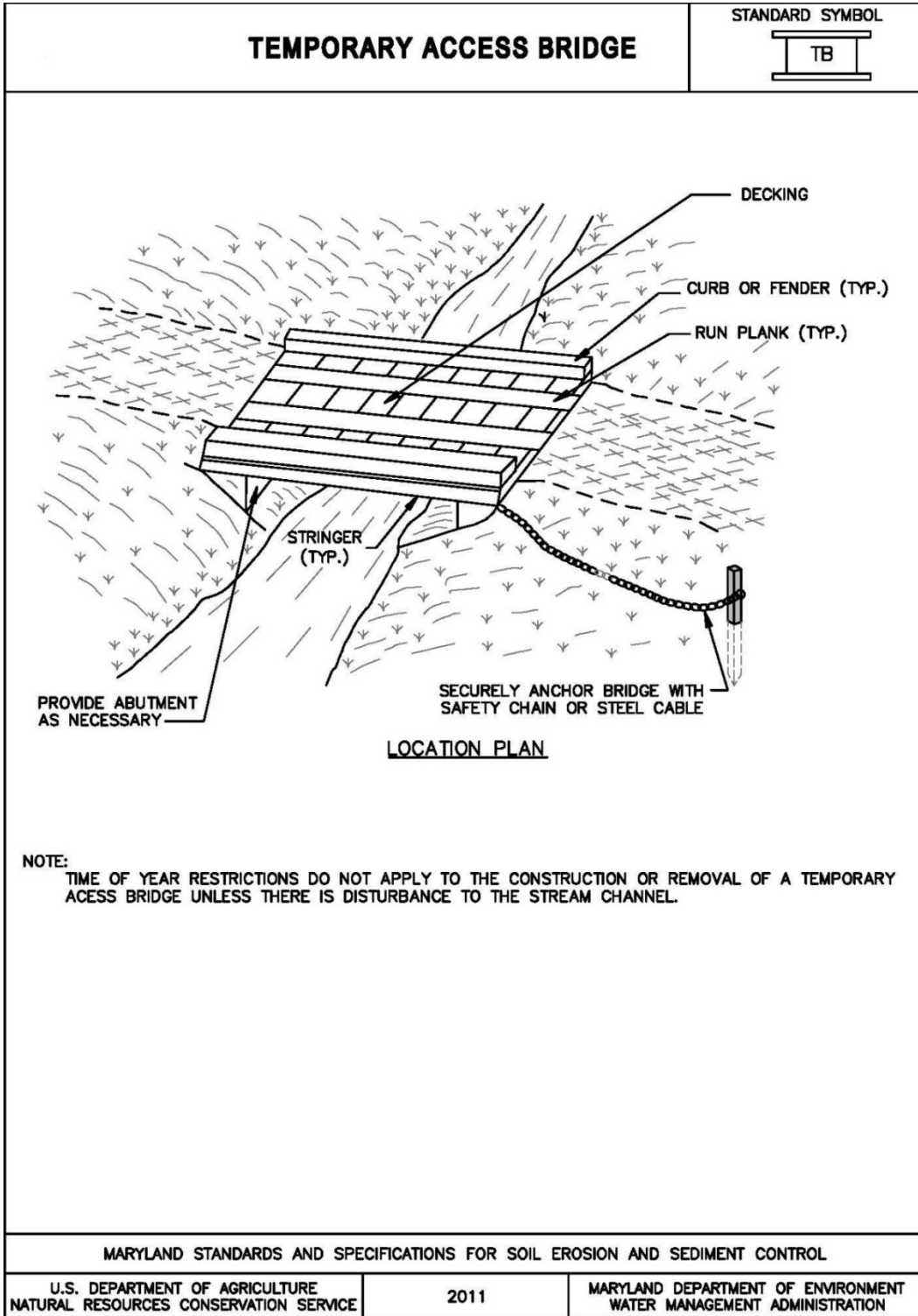

## Diagram 10.1 Portable Skidder Timber Bridge Design

WIT-02-0061

### A Portable Skidder Timber Bridge Design



The USDA Forest Service San Dimas Technology and Development Center (SDTDC) and the Wood In Transportation (WIT) Program have developed a portable/temporary skidder bridge to cross drainages for field harvesting equipment. Its length is 16 feet, and width is 12 feet. It is constructed using three 4-foot-wide preconstructed laminated panels. The exterior panels have 8-inch wide by 8-inch high curbs making the travelway width 10 feet 8 inches. The bridge is designed to carry a 27,000-pound axle load, which equates to a Caterpillar 525 Skidder with an 8,000-pound grapple load. One major goal of this project was to design a lightweight easy to install bridge that would aid in minimizing erosion and sedimentation at stream crossings.

The panels are preassembled, and field equipment, such as a skidder can be used to install the bridge. The bridge rests on 4-inch by 8-inch sills. Each sill has guide plates to secure the panels in place.

Acceptable species and grades are shown in table 1. Any species of wood may be used providing its unfactored bending strength is at least 875 pounds per square inch. SDTDC evaluated bolted panels, but the panels can be glued or nail laminated (see note 1).

This bridge is structurally adequate for 3- or 5-axle log trucks. However, due to its narrow width, minimal curb system, and large live load deflection, log truck traffic should be limited to occasional trucks operating at low speeds.

Dynamic effects caused by rough approaches, or bumps at the ends of bridges, can significantly increase wear and damage to bridges. Approaches to bridges should be initially graded and maintained at a relatively smooth and level surface.

This project was completed by: James R. Bassel, Project Leader, USDA Forest Service, San Dimas, CA  
Merv Eriksson, Structural Engineer, USDA Forest Service, Missoula, MT

For additional information, visit the Wood In Transportation website at [www.fs.fed.us/na/wit](http://www.fs.fed.us/na/wit), or call the National Wood In Transportation Information Center at (304) 285-1591.



USDA Forest Service



San Dimas Technology  
and Development Center



Wood In Transportation

## Diagram 10.1.a Portable Skidder Timber Bridge Design: Material List

### FIELD EVALUATION

The Homochitto National Forest in Mississippi evaluated this design. The Forest used red oak common to the area. The bridge has been used on three different sales and has carried more than a million board feet of timber. The Forest was pleased that the drainages were not disturbed, and the contractor was able to save time by traveling over the drainages rather than around them.

Two men assembled the bridge panels in two days. Installation of the bridge panels at the site takes two men 30 minutes using standard field equipment.

**Approximate Material Cost:**

Wood	\$1,500.00
Hardware	150.00
Total	\$1,650.00

**Forest Contact:**

Lee Dunnan  
National Forests in Mississippi  
Homochitto Ranger District  
Rt. 1, Box 1  
Meadville, MS 39652  
(601) 384-5876

### SKIDDER BRIDGE MATERIAL LIST For Three Bolted 4-foot Panels using 4-inch by 8-inch Timbers

**Timber**

Note: The design requires a bridge depth of 8 inches. Any width timbers that have that depth can be used (e.g., 2-in by 8-in, 3-in by 8-in, etc.). SDTDC used 4-inch by 8-inch timbers. Exterior laminations must be 4 inches thick due to countersinking.

- 40 4-in by 8-in by 16 feet rough sawn timber (see Table 1)
- 2 4-in by 8-in by 12 feet rough sawn timber for sills (can use 16 feet length)

**Hardware for 4-foot panels**

- 24 3/4-inch by 4-foot rods with threads, 6 inches each end
- 48 3/4-inch nuts (heavy hexagon)
- 48 3/4-inch malleable iron washers

**Hardware for curbs**

- 8 3/4-inch by 18-inch bolts
- 8 3/4-inch nuts (heavy hexagon)
- 16 3/4-inch malleable iron washers

**Hardware for sill**

- 12 3/4-inch by 10-inch lag bolts
- 12 3/4-inch malleable iron washers

**Total Materials for Skidder Bridge**

- 42 4-in by 8-in by 16 feet rough sawn timber (using 16 feet for sills)
- 24 3/4-inch by 4-foot rods with threads, 6 inches each end
- 8 3/4-inch by 18-inch bolts
- 56 3/4-inch nuts (heavy hexagon)
- 76 5/8-inch malleable iron washers
- 12 3/4-inch by 10-inch lag bolt

---

The U.S. Department of Agriculture (USDA) prohibits discrimination in all its programs and activities on the basis of race, color, national origin, sex, religion, age, disability, political beliefs, sexual orientation, or marital or family status. (Not all prohibited bases apply to all programs.) Persons with disabilities who require alternative means for communication of program information (Braille, large print, audiotape, etc.) should contact USDA's TARGET Center at (202) 720-2600 (voice and TDD).

To file a complaint of discrimination, write USDA, Director, Office of Civil Rights, Room 326-W, Whitten Building, 1400 Independence Avenue, SW, Washington, D.C. 20250-9410 or call (202) 720-5964 (voice and TDD). USDA is an equal opportunity provider and employer.

\*\*\*\*\*

The USDA Forest Service hereby gives notice that the information herein contained shall not create any warranty expressed or implied. The person or organization using this information waives and relinquishes any and all claims against the United States of America, its officers, employees, and project cooperators, for any loss, damage, personal injury, or death incident to, or occurring as a consequence of, the use thereof.

September 2001

# Diagram 10.1.b Portable Skidder Timber Bridge Design: Isometric View

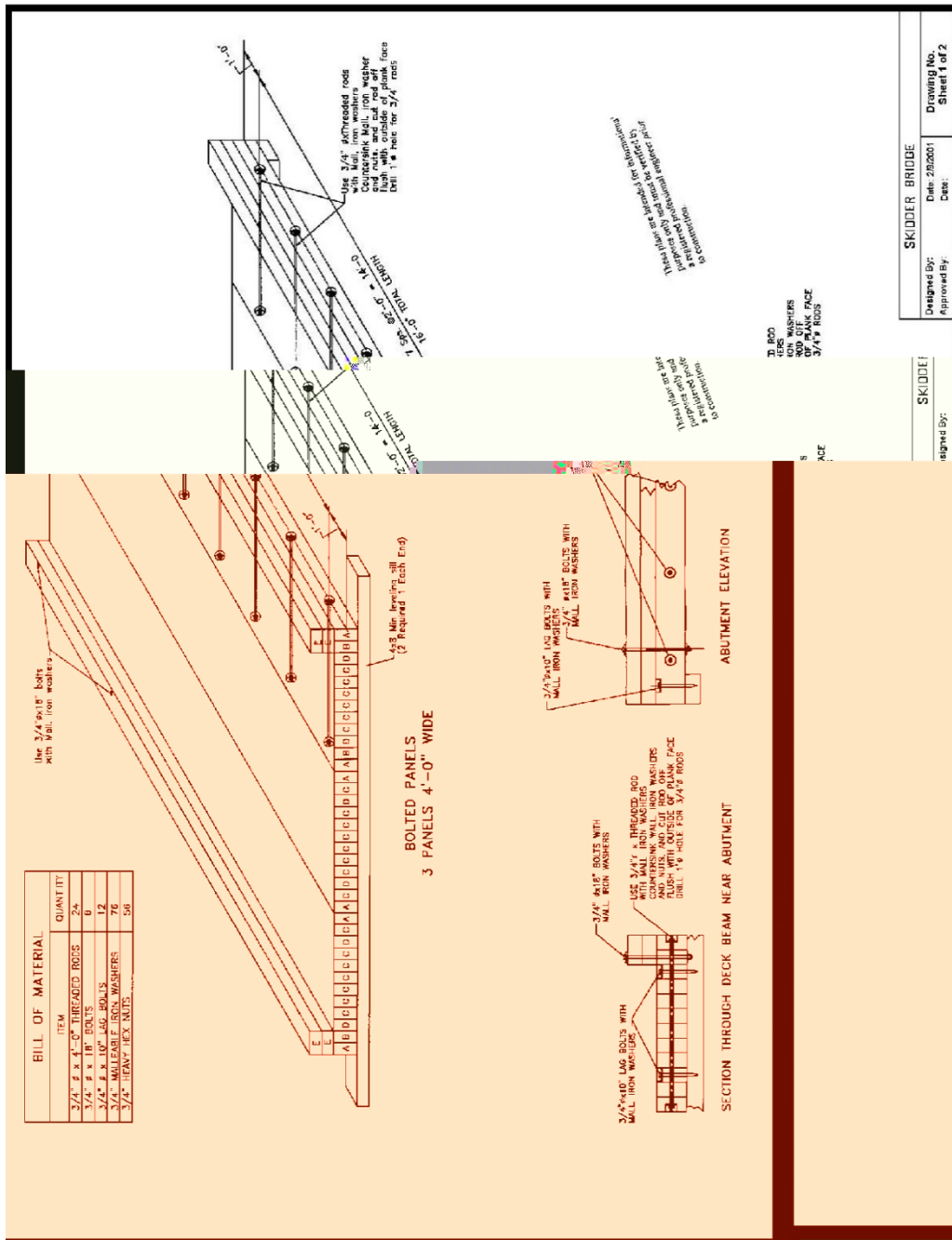



## Diagram 10.1.c Portable Skidder Timber Bridge Design: Sections

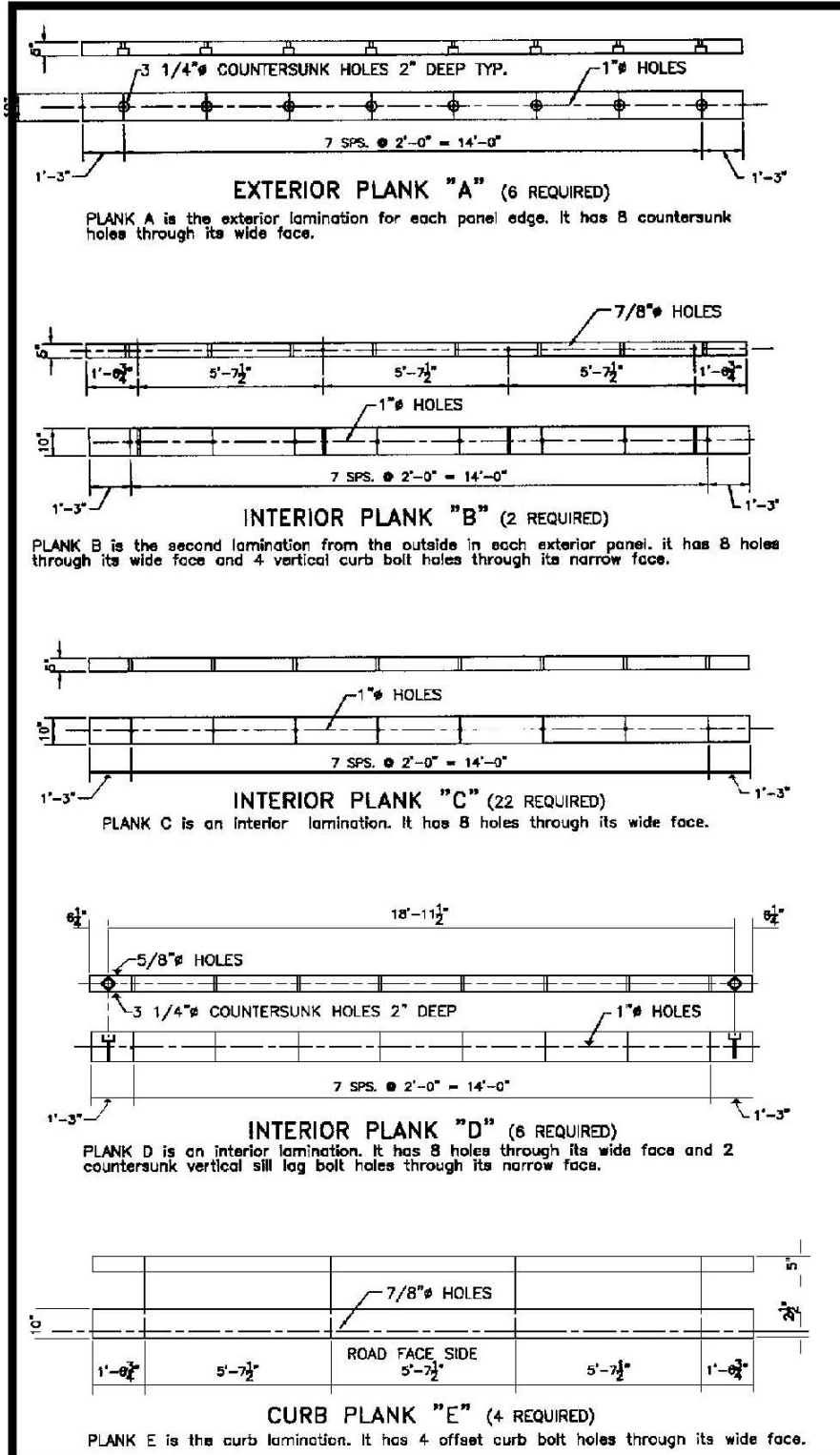

## Diagram 10.1.d Portable Skidder Timber Bridge Design: Notes

### SKIDDER BRIDGE NOTES:

1. **BRIDGE PANELS:** Three panels, 48 inches wide shall be fabricated from 4-inch thick by 8-inch wide laminations. Exterior panels shall have 8-inch wide by 8-inch high guide curbs as shown. The panels are shown bolted together.

The panels can also be glued laminated or nail laminated. If glued laminated, the panels shall be fabricated in conformance with AASHTO M168 and ANSI/AITC A190.1 and shall be manufactured to an industrial appearance using wet-use adhesives.

If nail laminated, each lamination shall be nailed using 10-inch deformed shank bridge spikes having a minimum shank diameter of 3/8" in pre-drilled 1/4" diameter holes. The spikes shall be spaced at 12 inches and staggered at 2 inches from the top and bottom of the planks.

2. **WOOD SPECIES AND GRADES :** Any species of wood may be used providing its tabulated, or unadjusted, allowable bending stress is not less than 875 pounds per square inch. Examples of acceptable species and grades are shown in Table 1. Expected use and expected life span should be considered when selecting a species. High volumes of skidded timber may require a hard, high-density species.

3. **PRESERVATIVES:** If the panels are to be used more than 1 or 2 years the timber should be pressure treated with an approved preservative. The timber shall be treated in conformance with AWPA C14 (soil contact) and the Best Management Practices for the Using Treated Wood in Aquatic and Wetland Environments. Insofar as is practical, all lumber shall be cut, drilled, and completely fabricated prior to pressure treatment.

4. **DESIGN LOADS:** These bridges are designed to carry a 27,000-pound skidder axle load. This skidder load corresponds to a Cat 525 with an 8,000-pound grapple load. The bridge will also support an AASHTO Type 3 Truck (3-axle dump truck), an AASHTO Type 3-S2 Truck (5-axle logging truck), an AASHTO HS 20 Truck (highway load vehicle), or a track mounted vehicle having a load, per track, of up to 1,300 pounds per lineal foot. The bridge is designed assuming exclusively the exterior panels carry all wheel and track loads. Larger skidder or track mounted vehicle loads, or overweight trucks, will require redesigned panels or shorter spans.

5. **DESIGN LIMITATIONS:** Although the bridge is structurally adequate for standard highway 3- or 5-axle trucks, because of the narrow width, minimal height curb system, and large live load deflections; truck traffic should be limited to occasional trucks operating at low speeds (10 miles per hour or less).

6. **DYNAMIC LOADING:** Dynamic effects caused by rough approaches, or bumps at the ends of the bridge can significantly increase live loading, resulting in excessive wear and damage to the bridge. Approaches to bridges should be graded, and maintained as a level-riding surface.

7. **HARDWARE:** Malleable iron washers shall be used under all nuts and bolt heads unless the bolts are timber or dome head. Bolts and lag bolts shall comply with the requirements of ANSI/ASME Standard B18.2.1-1981, Grade 2. Any other steel components shall comply with ASTM A36.

8. **INSTALLATION AND REMOVAL:** Bridge panels may be prefabricated or assembled in place. Panels should be placed on, and attached to, the leveling sills as shown. Foundations should be leveled and compacted as necessary to provide a solid bearing surface for the leveling sill. Timber members and panels should be stored and handled so as not to damage the material. If damage does occur, exposed untreated wood should be field treated in accordance with AASHTO M 133.

**TABLE 1**

SPECIES GROUPS	VISUALGRADE*	EXT. PANEL WEIGHT (Lbs)**
Cottonwood	Select Structural	1,750
Doug Fir/Larch	No. 2	2,200-2,350
Hemlock/Fir	No. 1	1,500-2,150
Red Maple	No. 1	2,450
Southern Pine	No. 2	2,300-2,600
Spruce/Pine/Fir	No. 1	1,750-2,050
Western Woods	Select Structural	1,750-2,350

\* Lumber must be graded.

\*\* Weights assume creosote treatment and 20% moisture content. Weights vary in multiple species groups

These plans are intended for informational purposes only and must be verified by a registered professional engineer prior to construction.

SKIDDER BRIDGE		
Designed By: <i>John S. ...</i>	Date: 2/9/2001	DRAWING NO.
Approved By: .	Date: .	SHEET 2 OF 2

## **SPECIFICATIONS FOR TEMPORARY ACCESS WATERWAY CROSSING – CULVERT**

### **Definition**

A *temporary access culvert* is a structure consisting of a section of circular pipe, pipe arches, or oval pipes of reinforced concrete, corrugated metal, or structural plate that is used to convey flowing water under a waterway or channel crossing.

### **Considerations**

1. Temporary culverts are used where:
  - a. The channel is too wide for normal bridge construction; or
  - b. Anticipated loading may prove unsafe for single-span bridges.
2. This temporary waterway crossing practice is normally preferred over a ford type of crossing because disturbance to the waterway is only during construction and removal of the culvert.
3. Temporary culverts can be salvaged and reused.

### **Specifications**

1. All culverts shall be strong enough to support their cross-sectional area under the maximum expected loads.
2. The size of the culvert pipe shall be the largest pipe diameter that will fit into the existing channel without major excavation of the waterway channel or without major approach fills, or as specified by an approved Waterway Construction Permit. If a channel width exceeds 3 feet, additional pipes may be used until the cross-sectional area of the pipes is greater than 60 percent of the cross-sectional area of the existing channel. The minimum size culvert that may be used is a 12-inch-diameter pipe. In all cases, the pipes shall be large enough to convey normal stream flows.
3. The culverts shall extend a minimum of 1 foot beyond the upstream and downstream toe of the aggregate placed around the culvert.
4. Non-woven geotextile shall be placed on the streambed and stream banks prior to placement of the pipe culvert(s) and aggregate. The geotextile shall cover the streambed and extend a



minimum 6 inches and a maximum 1 foot beyond the end of the culvert and bedding material. Use of geotextile reduces settlement and improves the crossing stability<sup>37</sup>.

5. The invert elevation of the culvert shall be installed on the natural streambed grade to minimize interference with fish migration, thus allowing for free passage of fish.
6. The culverts shall be covered with a minimum of 1 foot of washed aggregate. If multiple culverts are used, they shall be separated by at least 12 inches of compacted aggregate fill.
7. All areas disturbed during culvert installation shall be ***stabilized within 24 hours of the disturbance***.

### **Maintenance**

1. Periodic inspection shall be performed to ensure that the culverts, streambed, and stream banks are not damaged, fish passage or migration is not blocked, and that sediment is not entering the stream.
2. Maintenance shall be performed, as needed, in a timely manner, to ensure that structures are in compliance with these specifications. This shall include removal and disposal of any sediment or trapped debris. Sediment shall be disposed of and stabilized outside the waterway floodplain.

### **Culvert Removal and Cleanup Requirements**

1. When the crossing has served its purpose, all structures including culverts, bedding, and geotextile materials shall be ***removed within 14 calendar days***, unless a time of year restriction is in place.
2. Final cleanup shall consist of removal of the temporary structure from the waterway, removal of all construction materials, restoration of original stream channel cross-section, and protection of the stream banks from erosion. Removed material shall be stored outside of the waterway floodplain.
3. Removal of the structure and cleanup of the area shall be accomplished without construction equipment working in the waterway channel.
4. All areas disturbed during culvert removal and the stream banks shall be stabilized with erosion control matting ***within 24 hours of the disturbance***.

---

<sup>37</sup> Use non-woven geotextile as specified in Appendix J.

**Diagram 11.0**  
**Temporary Access Waterway Crossing - Culvert**

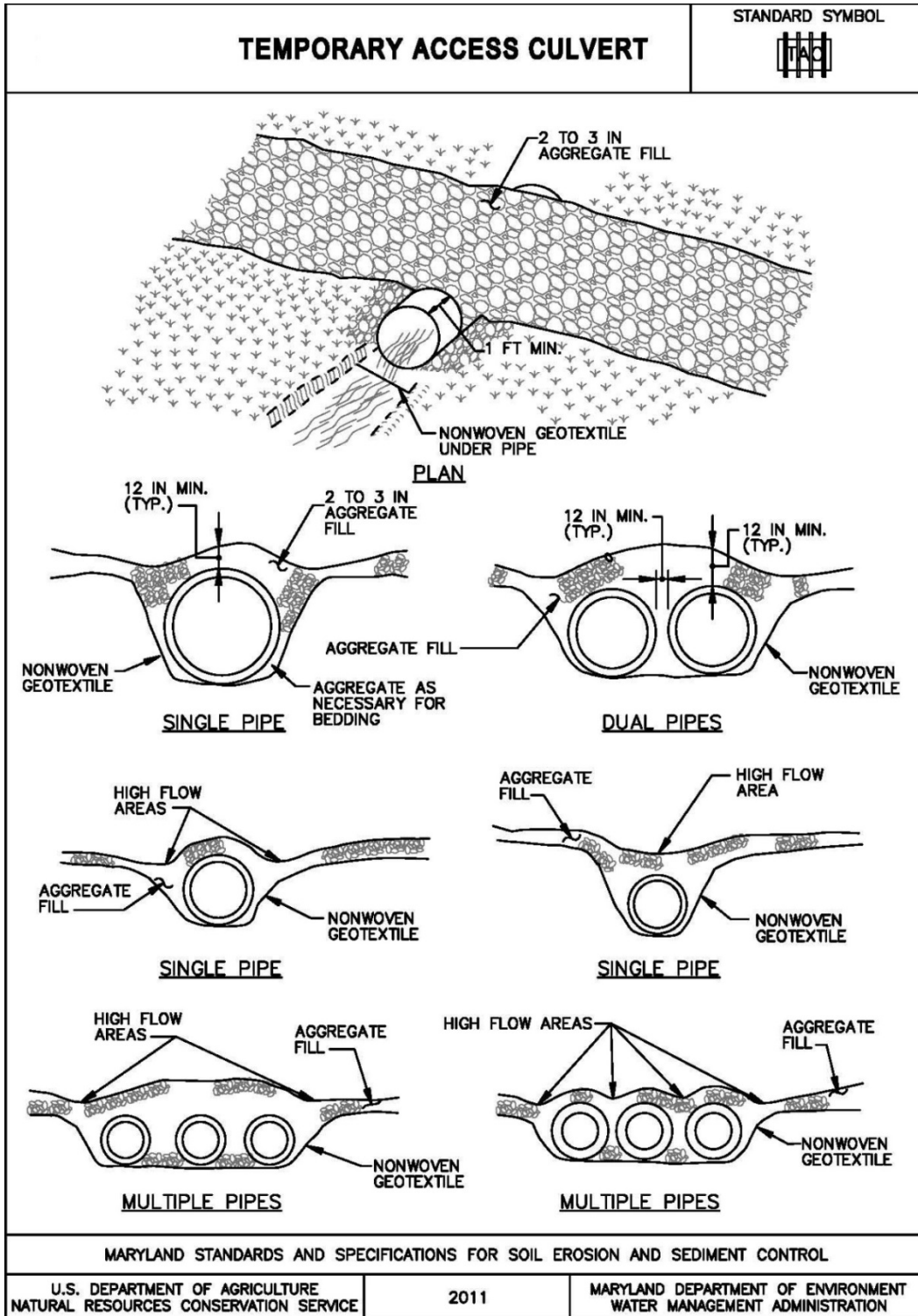

## SPECIFICATIONS FOR TEMPORARY ACCESS WATERWAY CROSSINGS – FORD

### Definition

A *temporary access ford* is a shallow structure placed in the bottom of the waterway, over which the water flows, to allow traffic to cross the waterway.

### Considerations

Temporary fords may be allowed when bridge or culvert crossings are not possible and the streambed is armored with naturally occurring bedrock, or can be protected with an aggregate layer. Below are general specifications: however, any requirements that are part of an approved Waterway Construction Permit will take precedent.

### Specifications

1. The approaches to the structure shall consist of stone pads. Other materials may be approved by the SCD. The entire ford approach (where banks were cut) shall be covered with non-woven geotextile and protected with aggregate to a depth of 4 inches.
2. Fords shall be prohibited when the stream banks are 4 feet or more in height above the invert of the stream.
3. The approach roads at the cut banks shall be no steeper than 5:1. Spoil material from the banks shall be stored out of the floodplain and stabilized.
4. One layer of non-woven geotextile<sup>38</sup> shall be placed on the streambed, stream banks, and road approaches prior to placing the bedding material on the stream channel or approaches. The geotextile shall extend a minimum of 6 inches and a maximum of 12 inches beyond the bedding material.
5. The bedding material shall be coarse aggregate.
6. All fords shall be constructed to minimize the blockage of stream flow and shall allow free flow over the ford. The placing of any material in the waterway bed will cause some upstream ponding. The depth of this ponding will be equivalent to the depth of the material placed within the stream and, therefore, should be kept to a minimum height. However, in no case shall the bedding material be placed deeper than 12 inches or one-half (1/2) the height of the existing banks, whichever is smaller.
7. All areas disturbed during ford installation shall be *stabilized within 24 hours of that disturbance*.

---

<sup>38</sup> See Appendix J.

## **Maintenance**

1. Periodic inspection shall be performed to ensure that the fords, streambed, and stream banks are not damaged, fish passage or migration is not blocked, and that sediment is not entering the stream.
2. Maintenance shall be performed, as needed, in a timely manner, to ensure that structures are in compliance with these specifications. This shall include removal and disposal of any sediment or trapped debris. Sediment shall be disposed of and stabilized outside the waterway floodplain.

## **Ford Removal and Final Cleanup**

1. When the temporary structure has served its purpose it shall be removed completely.
2. Final clean up shall consist of removal of temporary ford materials from the waterway.
3. All material shall be stored outside of the waterway floodplain.
4. The removal shall not create an impoundment or fish passage restriction.
5. Cleanup shall be accomplished without construction equipment working in the stream channel.
6. The approach slopes of the cut banks shall not be backfilled.
7. All areas disturbed during ford removal shall be *stabilized within 24 hours of that disturbance*.

**Diagram 12.0**  
**Temporary Access Waterway Crossing – Ford**

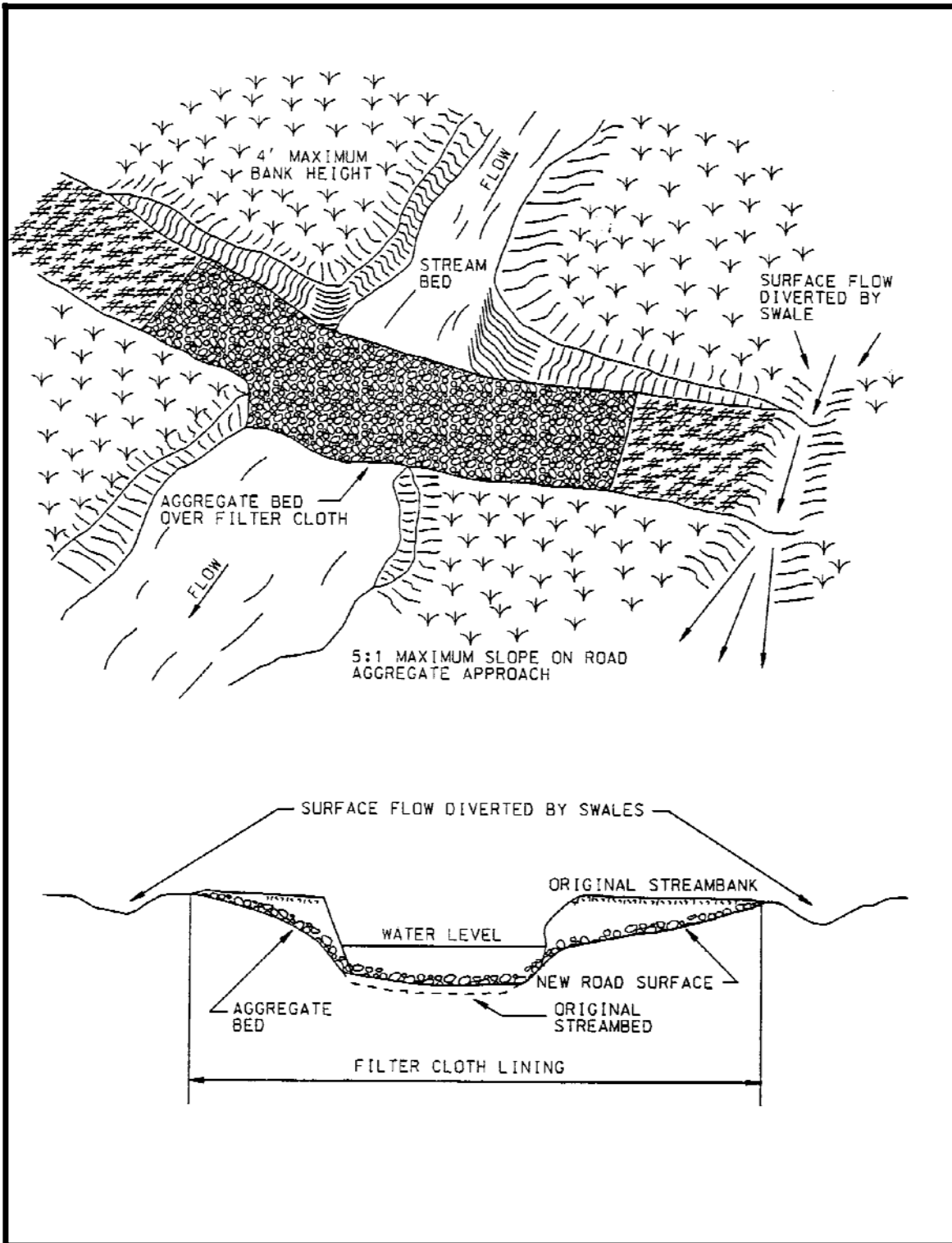

## **SPECIFICATIONS FOR LOGGING MATS**

### **Definition**

A *logging mat* is a portable fabrication, usually constructed of boards or timbers and held together by bolts or cable, to provide temporary protection of a forest harvest entrance or haul road.

### **Purpose**

This practice protects the surface soil structure from excessive compaction and rutting.

### **Conditions Where Practice Applies**

This practice applies to any part of the forest harvest access system where rutting could become an erosion or water handling problem. It is often used as a substitute for stone or other stabilizing materials at the entrance of a forest harvest site and isolated wet areas on haul roads or skid trails.

### **Specifications**

1. Mats shall be placed end-to-end to form a continuous span for the entire length of the area to be protected.
2. Mats can be used as a substitute for or in conjunction with stone, gravel, wood chips, culverts, or other stabilizing material at the entrance to the harvest site.
3. Mats shall be inspected frequently and maintained or replaced as necessary to ensure their proper function.

**Diagram 13.0**  
**Logging Mats**

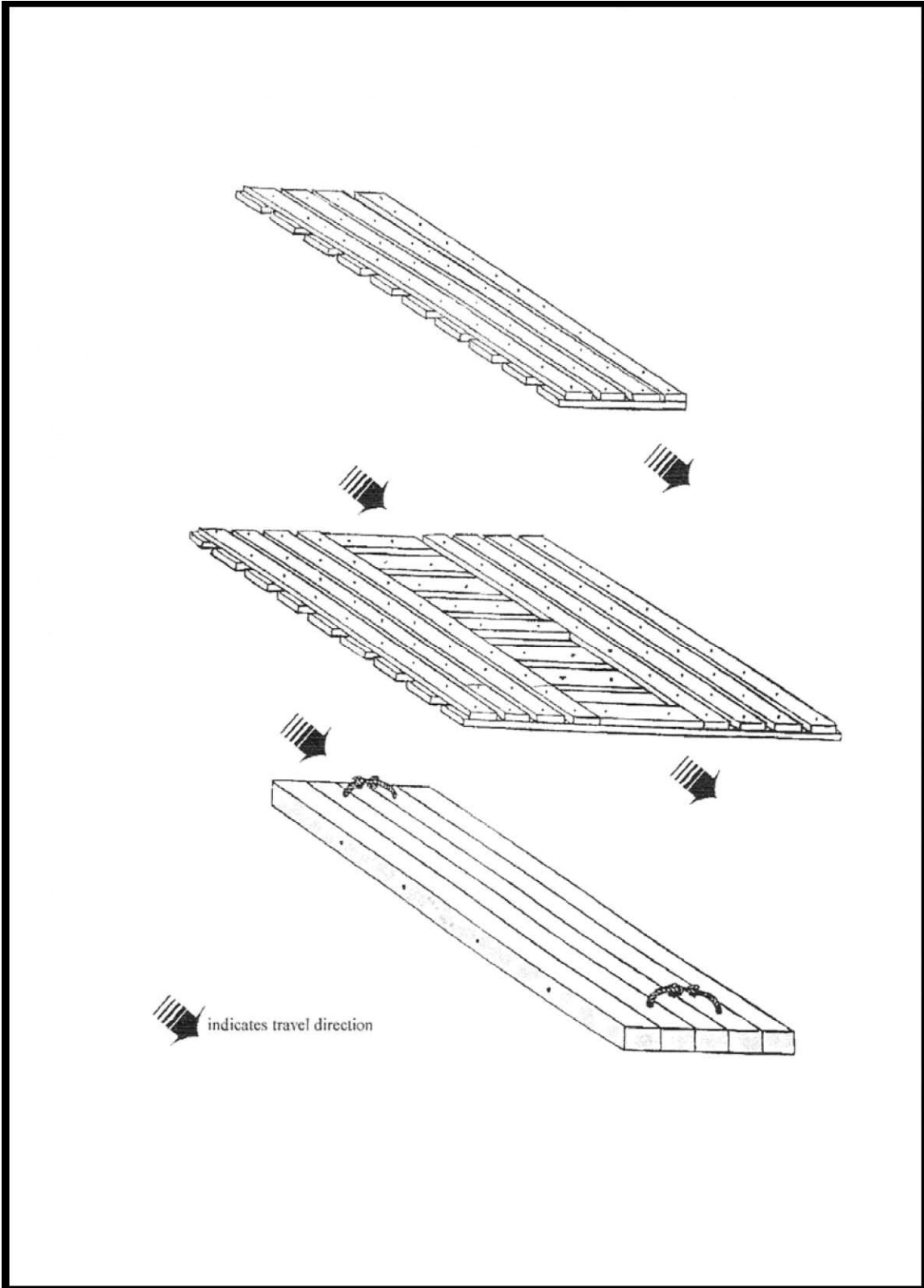

## SPECIFICATIONS FOR STRAW BALE DIKE

### Definition

A *straw bale dike* is a temporary barrier of straw or similar material used to intercept sheet flow.

### Purpose

The straw bale dike filters sediment from runoff. The dike also intercepts sheet flow and slows the velocity of the runoff so that deposition of transported sediment can occur. The straw bale dike is used to intercept or direct sediment-laden runoff so the deposition of transported sediment can occur. ***Do not use as a velocity check in ditches, swales, or in places where concentrated flow is intercepted.***

### Conditions Where Practice Applies

1. A straw bale dike is constructed where sediment-laden runoff needs to be intercepted at the base of a disturbed slope. This practice is installed only where sheet flow conditions exist. The straw bale dike shall be maintained continuously and remain in place along the downgrade perimeter of disturbed areas until the disturbed areas are permanently stabilized.
2. The use of this practice is especially important where the forest floor has been disturbed within a SMZ. Under these circumstances, structural perimeter control must be installed prior to the start of and maintained during the harvest.

### Specifications

1. Straw bales shall be placed on the contour and in a row with the ends of each bale tightly abutting the adjacent bales. The straw bale dike shall be positioned to intercept sheet flow only, and shall never be used as velocity checks in areas of concentrated flow.
2. Each bale shall be entrenched in the soil a minimum of 4 inches and placed so the bindings are horizontal.
3. Bales shall be securely anchored in place by either two (2) stakes or rebars driven through the bale 12 to 18 inches into the ground. The first stake in each bale shall be driven toward the previously laid bale at an angle to force the bales together. Stakes shall be driven flush with the top of the bale.
4. Straw bale dikes shall be inspected frequently, after each rain event, and maintenance performed as necessary. Replace bales when deteriorated.



5. All bales shall be removed when the site has been stabilized. However, bales may be left if they are used as part of the stabilization process. If bales are removed, the trench where the bales were located shall be graded flush and stabilized.
6. Straw bale dikes have a normal service life of three (3) months. Replace bales as needed.
7. Straw bale dikes shall not be used on slopes exceeding 5:1.
8. The length of straw bale dikes must conform to the criteria in the following table:

**Table 7 – Straw Bale Dike Slope Length and Steepness Design Criteria**

<b>Slope</b>	<b>Slope Steepness (H:V)</b>	<b>Slope Length (feet)</b>	<b>Dike Length (feet)</b>
0% to 2%	Flatter than 50:1	300	500
2% to 10%	50:1 to 10:1	125	500
10% to 20%	10:1 to 5:1	100	500

**Diagram 14.0  
Straw Bale Dike**

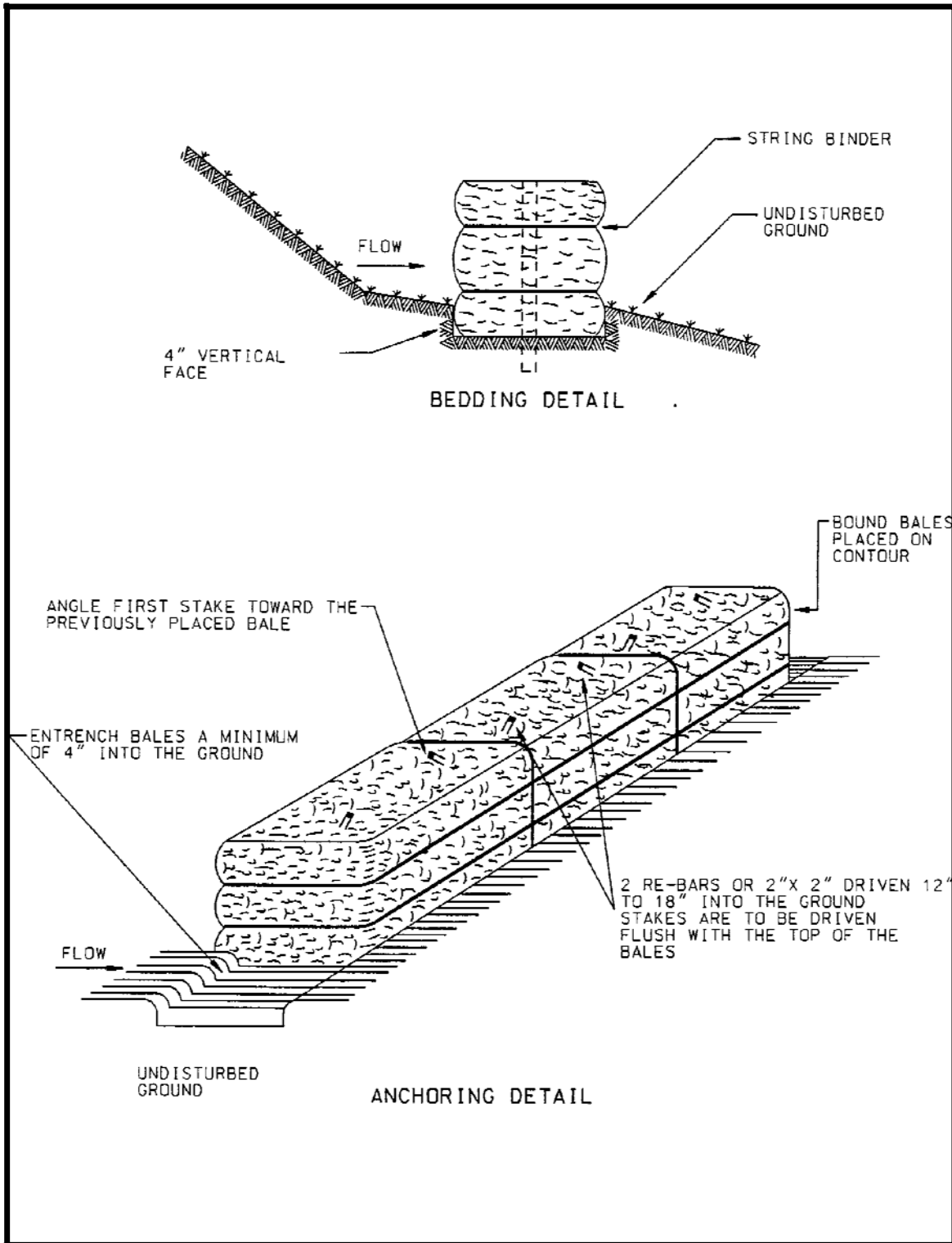

## SPECIFICATIONS FOR SILT FENCE

### Definition

A *silt fence* is a temporary barrier of woven slit film geotextile used to intercept sheet flow from disturbed areas and to filter surface runoff.

### Purpose

Silt fences filter sediment from runoff. The fence also intercepts sheet flow and slows the velocity of the runoff so that deposition of transported sediment can occur. Silt fences can be used to intercept sheet flow only. ***Do not use as a velocity check*** in ditches, swales, or in places where concentrated flow is intercepted.

The use of this practice is especially important where the forest floor has been disturbed within a SMZ. Under these circumstances, structural perimeter control must be installed prior to the start of and maintained during the harvest.

### Conditions Where Practice Applies

Silt fence is limited to intercepting sheet flow runoff from limited distances according to slope. Silt fence provides filtering and velocity dissipation to promote gravity settling of sediments.

### Specifications

1. Silt fence shall not be used in rocky soils that prevent trenching.
2. Silt fence shall be placed on the contours.
3. Downslope from the silt fence shall be undisturbed ground.
4. Fence posts shall be a minimum of 36 inches long, driven 16 inches minimum into the ground. Wood posts shall be 1 ¾ inches x 1 ¾ inches (minimum) square cut and of sound quality hardwood. As an alternative to wood, use standard T or U section steel posts weighing not less than 1 pound per linear foot.
5. The length of silt fences must conform to the criteria in the following table:

**Table 8 – Silt Fence Slope Length and Fence Length Design Criteria**

<b>Slope %</b>	<b>Maximum Slope Length (feet)</b>	<b>Maximum Silt Fence Length (feet)</b>
Less than 2	300	Unlimited
2 – 10	125	1,000
10 – 20	100	750
Greater than 20	40	250

6. In areas of less than 2 percent slope and sandy soils, maximum slope length and silt fence length can be unlimited.
7. Woven slit film geotextile shall be fastened securely to up-slope side of the fence post with wire ties or staples at top and mid-section. The geotextile shall meet the specifications in Appendix J.
8. Embed geotextile a minimum of 8 inches vertically into the ground, backfill, and compact the soil on both sides of the fabric.
9. Where ends of geotextile fabric come together, they shall be overlapped, folded, and fastened to prevent sediment bypass.
10. Extend both ends of the silt fence a minimum of 5 horizontal feet up-slope at 45 degrees to the main fence alignment to prevent runoff from going around the ends of the silt fence.

**Maintenance**

Silt fence shall be inspected after each rainfall event, and maintained when bulges occur or when sediment accumulation reaches 25 percent of the fabric height. The geotextile must be replaced if torn.

**Diagram 15.0**  
**Silt Fence**

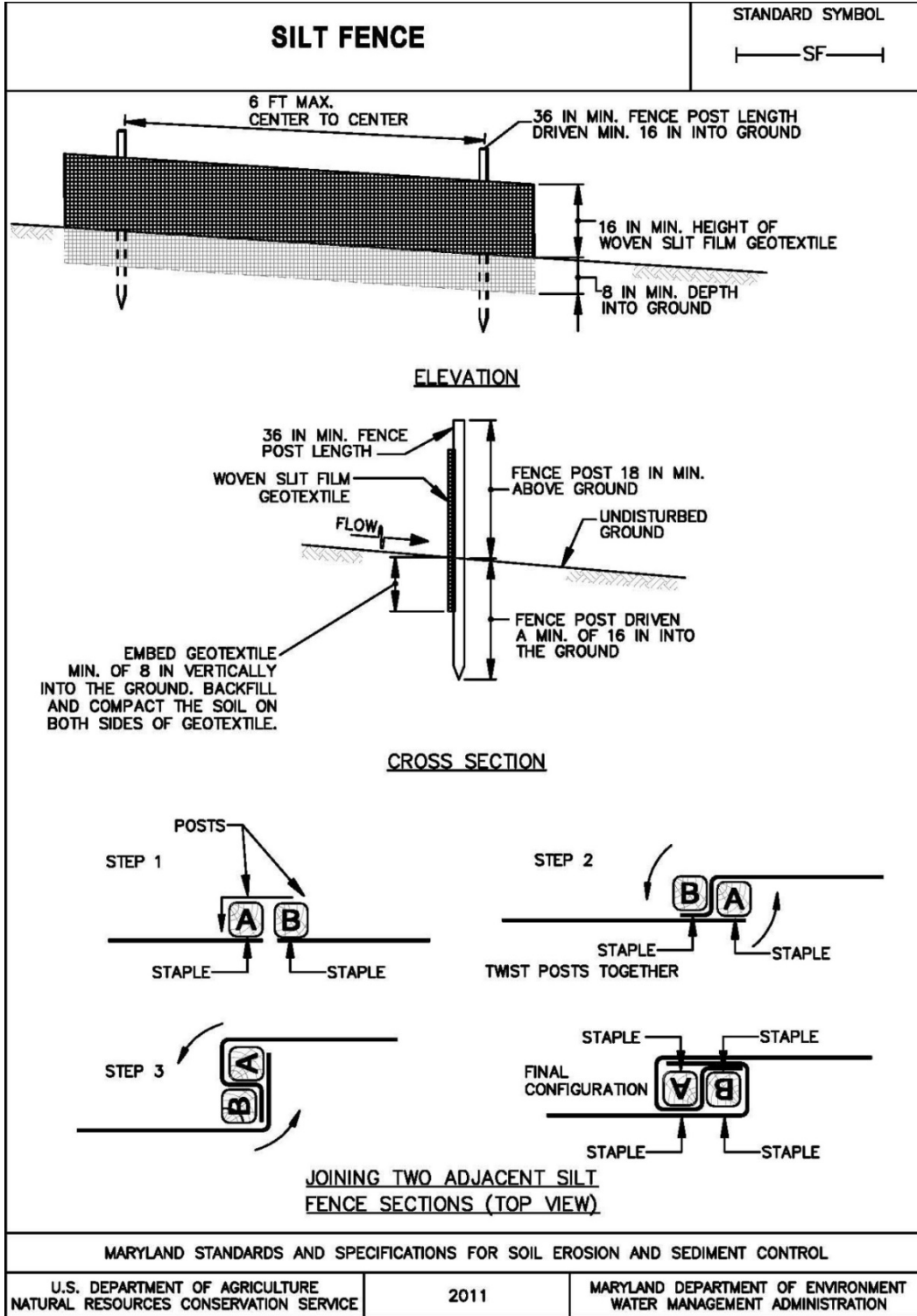

## Category 3: Revegetation of Disturbed Soils

### SPECIFICATIONS FOR REVEGETATION OF DISTURBED SOILS

#### Definition

This practice provides for *revegetation of disturbed soils* by establishing grass and/or legume vegetation on bare soil areas.

#### Purpose

This practice re-establishes vegetative cover on soil that was disturbed during the harvest process. Revegetation minimizes erosion and sediment export to watercourses. Consideration should be given to seeding mixtures beneficial to wildlife, shade tolerance and composed of native species.

#### Conditions When Practice Applies

This practice shall be applied on disturbed forestland areas where (1) normal harvesting activities have exposed the soil and (2) it is explicitly required to vegetatively stabilize the area to prevent or mitigate erosion and sedimentation. Areas of special consideration include areas with highly erodible soils, steep slopes, and long slope lengths.

#### Specifications

**NOTE:** These specifications are based upon a USDA Code 342<sup>39</sup>.

1. Soils with increased erosion potential that were exposed during harvest operations will be ***stabilized within three (3) days of disturbance*** with seed and mulch. This includes areas:
  - a. With slopes greater than 5 percent ***and*** within 50 feet of a water body.
  - b. Within 50 feet of other sensitive areas (*e.g.*, property lines, protected habitat).
2. ***Within seven (7) days of completion of the harvest or a portion of the harvest***, all disturbed areas on roads, trails, and landings, which are located on slopes 10 percent or greater, shall be graded or backdragged, seeded and mulched, according to specifications. Disturbed areas on slopes less than 10 percent shall be graded or backdragged and left in a condition that permits successful natural regeneration of vegetation. Seeding and mulching will be required on critical areas (*i.e.* areas where the soil is especially subject to erosion).

---

<sup>39</sup> USDA, NRCS Code 342 is provided in Appendix C.

3. Site and Seedbed Preparation: Complete all grading and the loosening of compacted soil and install all water control measures prior to preparing a suitable seedbed.
4. Lime and Fertilizer: Forest soils have natural fertility and pH levels that are acceptable for establishing shade-tolerant grasses. There is no requirement to add lime or fertilizer under normal conditions. If there is concern about soil fertility, the local Maryland Extension County Office will send soil samples for testing for a small charge. If the soil tests show a need, apply lime and fertilizer at recommended rates, incorporating the additives into the soil by surface roughening.
5. Seeding: Selected seed mixtures may be broadcast, drilled, or hydroseeded. Successful seedings are usually conducted in the spring and fall. If broadcasting seed, small or light seed can be mixed with a filler (*e.g.*, sawdust) to provide adequate distribution. Incorporate seed  $\frac{1}{8}$  to  $\frac{1}{4}$  inch deep by raking, dragging, cultipacking, or tracking with heavy machinery. Avoid seeding during windy conditions.
6. Mulching: Mulch shall be applied to all seeded areas immediately after seeding.

If grading is completed outside of the seeding season, mulch alone shall be applied and maintained until the seeding season returns. Mulch should be removed, the site seeded, and then mulch should be reapplied after seeding is completed.

When straw mulch is used, it shall be spread over all seeded areas at the rate of 2 tons per acre (100 lbs. per 1000 sq. ft.). Mulch shall be applied to a uniform loose depth of between 1 and 2 inches. Mulch applied shall achieve a uniform distribution and depth so that the soil surface is not exposed.

## **Maintenance**

1. After the vegetation is established, the site shall have 95 percent groundcover to be considered adequately stabilized. If the vegetation provides less than 40 percent ground coverage, restabilize following the original seedbed preparation and seeding recommendations. If the vegetation provides between 40 percent and 94 percent ground coverage, overseeding using one-half ( $\frac{1}{2}$ ) of the rates originally applied shall be necessary.
2. Mowing can be utilized to maintain roads that will be used in the future and/or to maintain open areas for wildlife. When possible, delay mowing until late summer to allow wildlife nesting to be completed, but in time for regrowth before winter. Prevent livestock grazing until plants are well established. Seeded areas must be protected from traffic, particularly during wet periods, if rutting is to be prevented. Freshly seeded roads are particularly vulnerable to damage. Use gates, boulders, or logs to restrict vehicular access.

**Table 9 – Nurse Crops (Temporary Seeding) To Be Added To  
Permanent Seeding Mixes <sup>(1)</sup>**

Mix	Recommended Cultivar	Seeding Rate		Soil Moisture Condition	Remarks
		lbs. / acre	lbs. / 1000 sq. ft.		
Annual Ryegrass <i>Lolium perenne</i> ssp. <i>Multiflorum</i>	Common	13	0.3	Dry to moist	<b>Planting dates:</b> Western Maryland – August 1 to Sept 30 March 15 to May 31 Piedmont – August 1 to Oct 15 March 1 to May 15 Coastal Plain – August 15 to Nov 30 Feb 15 to April 30
Barley <i>Hordeum vulgare</i>	Common	32	0.7	Dry to Moderately Dry	
Oats <i>Avena sativa</i>	Common	24	0.6	Dry to moist	
Wheat <i>Triticum aestivum</i>	Common	40	0.9	Dry to Moderately Dry	
Foxtail Millet <i>Setaria italica</i>	Common	10	0.2	Dry to moist	<b>Planting dates:</b> Western Maryland – June 1 to July 31 Piedmont – May 16 to July 31 Coastal Plain – May 1 to August 14
Pearl Millet <i>Pennisetum glaucum</i>	Common	7	0.2	Dry to moist	

- (1) Select a nurse crop to add to the permanent seeding mix, based on the time of year for planting. Use only one (1) nurse crop for each permanent seeding mix. Do not use a mixture of nurse crops.



**Table 10 – Permanent Seeding Mixtures**

Mix	Recommended Cultivar	Seeding Rate		Soil Drainage Class	Wildlife Value	Remarks
		lbs. / acre	lbs. / 1000 sq. ft.			
1 Hard Fescue  AND ADD: Kentucky Bluegrass  Perennial Ryegrass	Common or Bighorn  MD turf-types(1)  Blazer(II) or Pennfine	40  40  20	0.92  0.92  0.46	Well Drained to Somewhat Poorly Drained	Low	For best results, recommend using a blend of 3 cultivars of Kentucky Bluegrass
2 Creeping Red Fescue  Chewings Fescue  Kentucky Bluegrass OR Rough Bluegrass	Dawson, Flyer Pennlawn, Ruby, Fortress, or Salem  Common  MD turf-types(1) Common	30  30  20 20	0.69  0.69  0.46 0.46	Excessively Drained to Moderately Well Drained	Low	Use Rough Bluegrass on moist shady sites
3 Deertongue ( <i>Dicanthelium clandestinum</i> ) OR Sheep Fescue OR Canadian Wild Rye  Redtop  PLUS Common Lespedeza OR Korean Lespedeza	Tioga  Common or Bighorn Common  Streaker  Kobe Climax or Rowan	20  20 3  1  10 10	0.46  0.46 0.07  0.02  0.23 0.23	Excessively Drained to Moderately Well Drained	Moderate	Excellent for droughty acidic soils. Sheep Fescue, Canada Wild Rye, and Redtop are cool season grasses that will provide erosion protection while the warm weather Deertongue is becoming established.  Common Lespedeza is more tolerant of low acidity than Korean Lespedeza. These are both reseeding annuals.
4 Big Bluestem  Little Bluestem  Indiangrass  Creeping Red Fescue  <u>Plus one of the following:</u>  Partridge Pea Bush Clover Wild Indigo Showy tick-trefoil	Niagara or Rountree  Aldous or Blaze  Rumsey  Dawson, Pennlawn, Flyer, Ruby, Fortress, or Salem  Common Common Common Common	6  4  6  15  4 2 2 1	0.14  0.09  0.14  0.34  0.09 0.05 0.05 0.02	Excessively Drained to Moderately Well Drained	Moderate	All species are native to Maryland.  Creeping red fescue is a cool season grass that will provide erosion protection while the warm weather grasses are becoming established.

**Note for Table 10:** 1. Turf-type cultivars of Kentucky Bluegrass shall be selected based on recommendations of the University of Maryland Extension Service, *Turfgrass Technical Update TT-77*. Recommendations in the July, 2012 publication are that the following cultivars are suitable for general use:

Aries, Beyond, Blue Note, Courtyard, Diva, Everglade, Granite, Impact, Juliet, Midnight, NuGlade, Quantum Leap, Raven, Solar Eclipse, Sudden Impact, Touche, Yankee.

**Table 11 – Area Determinations for Roads  
(In Acres)**

Road Length (ft.)	Road Width (ft)					
	8	10	12	14	18	20
150	.03	.03	.04	.06	.06	.07
200	.04	.05	.06	.06	.08	.09
250	.05	.06	.07	.08	.10	.11
500	.09	.12	.14	.16	.21	.23
1000	.18	.23	.28	.32	.41	.46
1500	.28	.34	.41	.48	.62	.69
2000	.37	.46	.55	.64	.83	.92
2500	.46	.57	.69	.80	1.03	1.15
5000	.92	1.15	1.38	1.61	2.07	2.30
5280	.97	1.21	1.45	1.67	2.18	2.42

**Example:**

12-foot road width, 1500 feet in length has an area of .41 acres.

To determine amount of seeding material needed for a project, multiply the value in the above table by the recommended per acre application rate.

**Table 12 – Sample Seed Application Rates<sup>40</sup>**

Seed Type	Application Rate (lbs. / acre)	Area to be Seeded (acres from Table 11)	Seed to be Applied Total lbs.
Hard Fescue	40*	.41	16
Kentucky Bluegrass	40*	.41	16
Perennial Ryegrass	20*	.41	8
		Total Seed Applied	40

\*For example only.

<sup>40</sup> For actual seeding rates consult charts in this specification or Appendix C.

## GLOSSARY

The list of terms that follows is a representative sample of those used by foresters, lumbermen, loggers, soil scientists, biologists, engineers, conservationist planners, etc. Not all terms listed in the glossary are used in the text of this Manual, but are commonly used in conservation matters. Words designated with COMAR provide in whole or in part, the exact definitions as found in the Code of Maryland Regulations.

**Access Road:** A temporary or permanent access route for vehicles into forestland.

**Agricultural Drainage Project (COMAR):** Means the construction, reconstruction, or repair, or the straightening, widening, or deepening of any ditch, drain, canal, or other watercourse natural or manmade financed or managed by a public drainage association for the purpose of lowering the water level in the soil of adjacent lands for agricultural purposes.

**Approval Authority:** Means any soil conservation district, the specified agency named in a municipality not within a soil conservation district, the Washington Suburban Sanitary Commission, or the MDE Water Management Administration. (For the purposes of an approved erosion and sediment control plan for a forest harvest operation, the approval authority typically will be the local Soil Conservation District.)

**Bearing Capacity:** Maximum load that a material (soil) can support before failing.

**Bedding:** A site preparation method in which special equipment is used to concentrate surface soil and forest litter into a ridge 6 to 10 inches high, on which forest seedlings are to be planted.

**Berm:** A ridge of soil that is compacted and located in such a manner as to direct water to a desired location. Typically found adjacent to Public Drainage Association ditches as a result of placement of material removed from the channel during initial construction and subsequent maintenance operations.

**Best Management Practices (BMPs):** A practice or combination of practices for protection of water quality that is determined after an examination of alternative practices, and appropriate public participation, to be the most effective and practicable (including technological, economic, and institutional considerations) means of conducting a forest management operation while addressing any environmental considerations.

**Blue Line Stream:** A feature on a United States Geological Survey 7.5 Minute Series (Topographic) map representing perennial and intermittent streams. These features are shown as solid or dotted/dashed blue lines.

**Bottomlands:** A term often used to define lowlands adjacent to streams.

**Broad-Based Dip:** A surface drainage structure specifically designed to drain water from an access road while vehicles maintain normal travel speeds.

**Buffer:** Historical term for the relatively undisturbed area maintained on either side of Waters of the State during a forest harvest operation. It has been replaced with the term Streamside Management Zone with regards to forest harvest operations, but is still used when referring to nontidal wetlands and critical areas.

**Channel:** A natural stream that conveys water. A ditch or channel excavated to convey the flow of water.

**Clear (COMAR):** Any activity that removes the vegetative ground cover, without disturbing the root mat.

**Clearcut (Society of American Foresters):** A harvest method where essentially all trees have been removed in one operation, producing a fully exposed micro-climate for the development of a new forest stand.

**Contamination:** A general term signifying the introduction into water of microorganisms, chemicals, organic or inorganic wastes or sewage, or sediment which renders the water unfit for its intended use.

**Contour:** An imaginary line on the surface of the earth connecting points of the same elevation. A line drawn on a map connecting points of the same elevation.

**Culvert:** A conduit through which surface water can flow under roads.

**Custom Erosion and Sediment Control Plan (Custom Plan):** A plan designed for a specific site using criteria from this Manual and developed by a Licensed Professional Forester for a timber harvest operation. Required when site conditions prevent compliance with the requirements of the Standard Plan or when a stream crossing is proposed.

**Cut:** Portion of land surface or area from which earth has been removed or will be removed by excavation; the depth below original ground surface to the excavated surface.

**Cut and Fill:** Process of moving earth by excavating part of an area and using the excavated material for adjacent embankments or fill areas.

**DBH:** Diameter Breast Height. The diameter of a tree measured at 4.5 feet above the ground.

**Discharge (COMAR):**

- a. The addition, introduction, leaking, spilling, or emitting of any pollutant to Waters of the State; or
- b. The placing of a pollutant in a location where the pollutant is likely to pollute. Sediment has been defined as a pollutant to Waters of the State.

**Ditch:** A manmade conveyance for draining of water that has not resulted in a hydrological modification of a perennial stream (*e.g.*, by straightening, widening, or deepening). A ditch mapped as a solid or dotted/dashed blue line on a United State Geological Survey 7.5 Minute Series (Topographic) map shall be regarded as a perennial or intermittent stream and, therefore, be subject to the standards and specification related to Streamside Management Zones (SMZs).

**Diversion:** Typically, a channel with a supporting ridge on the lower side constructed for the purpose of intercepting surface runoff and diverting it around a work area.

**Ephemeral Channel:** A ground surface configuration (such as a swale) that contains flowing water only during and shortly after a rainfall event. The duration of flow is too limited to establish an aquatic ecosystem.

**Erosion (COMAR):** The process by which the land surface is worn away by the action of wind, water, ice, or gravity.

**Erosion and Sediment Control Plan (COMAR):** An erosion and sediment control strategy or plan to minimize erosion and prevent off-site sedimentation, by containing sediment on-site or passing sediment-laden runoff through a sediment control measure prepared and approved in accordance with the specific requirements of an approval authority, and designed in accordance with the handbook, *2011 Maryland Standards and Specifications for Soil Erosion and Sediment Control* and this Manual.

**Exemption:** Freedom from a duty. A circumstance where an activity is not subject to the provisions of a law or regulation. Typically, there is an explicit statement in a law or regulation that sets the specific conditions as to when an activity becomes subject to the provisions of the law or regulation.

**Fill:** The portion of land surface or area onto which excavated earth has been placed or will be placed; the height above original ground to the fill surface.

**Fill Slope:** The surface area formed where earth is deposited to build a road or trail.

**Ford:** Submerged stream crossing where tread is reinforced to bear intended traffic. A place where a flowing stream may be crossed by vehicle.

**Forestland:** Land bearing forest growth or land from which the forest has been removed, but which shows evidence of past forest occupancy and which is not now in other use.

**Forest Landowner:** An individual, combination of individuals, partnership, corporation, foundation, governmental agency, or association of whatever nature that holds an ownership interest in forestland.

**Forest Management Plan:** a plan, prepared by a Maryland Licensed Forester, addressing individual landowner objectives through specific guidance for managing forests and related resources to enhance and sustain the long term productivity of multiple forest resources.

**Forest Practice:** An activity relating to the growing, protecting, harvesting, or processing of forest tree species on forestland and to other forest management aspects such as wildlife, recreation, etc.

**Grade:** The slope of a road or trail expressed as a percent of change in elevation per unit of distance traveled.

**Grade (COMAR):** To cause the disturbance of the earth. This shall include but not be limited to any excavating, filling, stockpiling of earth materials, grubbing, root mat or top soil disturbance, or any combination of them.

**Gully Erosion:** Erosion process whereby water accumulates in narrow channels and over short periods of time removes soil from the narrow area to considerable depths (1 foot +).

**Harvesting:** The felling, loading, and transportation of forest products, roundwood, or logs.

**Humus Layer (Society of American Foresters):** The topmost soil layer of a forest floor consisting of decomposed litter and vegetation.

**Intermittent Stream:** A stream or portion of stream whose flow includes a seasonal or

temporary groundwater component (*i.e.* the base level of the stream is at or below the local water table). Such streams flow for days, weeks, or months following the most recent rainfall event. These streams may be shown as dotted/dashed lines on United States Geological Survey 7.5 Minute Series (Topographic) maps.

**Landing:** A place where logs are gathered in or near the forest for further transport, sometimes called a deck.

**Licensed Professional Forester (LPF):**

1. A person who is licensed by the Maryland Forestry Board of the Maryland Department of Labor and Licensing, and who for compensation applies scientific techniques to the planting, conservation, protection, and management of trees and related resources for their continuing use whether found in large numbers and areas commonly known as forests, woodlands, and wood lots, or in small groupings and individual trees in suburban and urban settings.
2. Under COMAR 26.17.01.07.C, one of five professionals authorized to certify that erosion and sediment control plans for forest harvest operations have been designed in accordance with approved erosion and sediment control ordinances, regulations, standards, and criteria.
3. Only a LPF is authorized to develop SMZ Plans.

**Logging Debris:** That unwanted, unutilized, and generally unmarketable accumulation of woody material, such as large limbs, tops, cull logs, and stumps, that remain as forest residue after timber harvesting.

**Mineral Soil:** Organic-free soil that contains rock less than 2 inches in maximum dimension.

**Mulch:** A natural or artificial layer of plant residue or other materials which, when placed on disturbed areas, particularly in association with seeding, conserves moisture, holds soil in place, aids in establishing plant cover, and minimizes temperature fluctuations.

**Mulching:** Covering forest soil with any loose cover of organic residues, such as grass, straw, bark, or wood fibers, to prevent erosion and stabilize exposed soil.

**Nonpoint Source Pollution:** Pollution that enters a water body from a diffuse origin on the watershed and does not result from discernable, confined, or discrete conveyances. Stormwater contaminated with sediment as a result of anthropogenic activities is an example of nonpoint source pollution.

**Nontidal Wetland (COMAR):** An area that is inundated or saturated by surface water or ground water at a frequency and duration sufficient to support, and that under normal circumstances does support, a prevalence of vegetation typically adapted for life in saturated soil conditions, commonly known as hydrophytic vegetation.

**Nontidal Wetlands of Special State Concern (COMAR):** The areas designated based on criteria in MDE Regulations, and listed in COMAR 26.23.06.01 as having exceptional ecological or educational value of State-wide significance.

**Nutrients:** Mineral elements in the forest ecosystem such as nitrogen, phosphorus, and potassium, which are naturally present or may be added to the forest environment by forest practices such as fertilizer or fire retardant applications. Substances necessary for the growth

and reproduction of organisms. In water, those substances that promote growth of algae and bacteria are chiefly nitrates and phosphates.

**Organics:** Particles of vegetation, other biologic material, or organic compounds that can degrade water quality by decreasing dissolved oxygen and by releasing organic solutes during leaching.

**Perennial Stream:** A stream whose flow includes a permanent groundwater component (*i.e.* the base level of the stream is at or below the local water table). Such streams flow year round. These streams may be shown as solid blue lines on United States Geological Survey 7.5 Minute Series (Topographic) maps.

**Permeability of Soil:** The capacity of a soil to move or transmit water or air through it. The permeability of a soil may be limited by the presence of one nearly impermeable soil horizon even though the others are permeable.

**Pollutant (COMAR):**

- (a) Any waste or wastewater that is discharged from:
  - (i) Any publicly owned treatment works, or
  - (ii) An industrial source; or
- (b) Any other liquid, gaseous, solid, or other substance that will contaminate any Waters of the State.

**Pollution (COMAR):** The contamination or other alteration of the physical, chemical, or biological properties of any Waters of the State, including change in temperature, taste, color, turbidity, or odor of the waters, or the discharge or deposit of any organic matter, harmful organisms, or liquid, gaseous, solid, radioactive, or other substance into any Waters of the State that will render the waters harmful, or detrimental, or injurious to:

- (a) Public health, safety or welfare;
- (b) Domestic, commercial, industrial, agricultural, recreational, or other legitimate beneficial uses; or
- (c) Livestock, wild animals, birds, fish or other aquatic life.

**Pre-harvest Planning:** The collection of information about an area to be harvested to aid in determining the best time for and method used to harvest. An effective pre-harvest plan will take into consideration all aspects of a timber harvest that may lead to water quality degradation and plan for the implementation of BMPs that will minimize the adverse effects of the operation. Elements of pre-harvest planning must consider the need for obtaining all approvals and permits for the project.

**Public Drainage Association (PDA):** An independent political subdivision; an organization established to locate, construct, or reconstruct, operate and maintain ditches, drains, and channels to provide agricultural and rural area drainage under the Local Government Article §26-104 and §26-401, Code of Maryland. The PDA maintains its ditches and adjacent areas to minimize sediment and erosion hazards.

**Public Drainage Association Ditch:** Any of the 800 miles of drainage ditches in the coastal zone, mostly on Maryland's Eastern Shore, that have operation and maintenance plans which

address sediment control and water quality protection.

**Regeneration:** The young tree crop replacing older trees removed by harvest or disaster; the process of replacing old trees with young.

**Residual Trees:** Live trees left standing after the completion of harvesting.

**Rill Erosion:** An erosion process in which numerous small channels only several inches deep are formed. Occurs mainly on disturbed and exposed soils.

**Riprap:** Large aggregate placed on erodible sites to reduce the impact of rain or surface runoff on these areas.

**Rolling Dip:** A shallow depression built diagonally across a light duty road or trail for the purpose of diverting surface water runoff from the road or trail.

**Runoff:** In forest areas, that portion of precipitation that flows from a drainage area on the land surface or in open channels.

**Ruts:** Depressions in access roads made by extended passage of heavy vehicles.

**Sediment (COMAR):** Soils or other surficial materials transported or deposited by the action of wind, water, ice, gravity, or by other artificial means.

**Seedbed:** The soil prepared by natural or artificial means to promote the germination of seed and the growth of seedlings.

**Sheet Erosion:** The removal of a fairly uniform layer of soil from the land surface by water runoff.

**Sheet Flow:** The passage of water over plane surfaces. Usually occurs in the headwaters of a stream's drainage area. Flow has shallow depth and is broad. The velocity of rainfall runoff moving in sheet flow condition is very low. According to the Natural Resources Conservation Service (NRCS), sheet flow changes to shallow concentrated flow after 100 to 300 feet.

**Silvicultural Activities:** All forest management activities, including logging, site preparation, forest regeneration, log transport, and forest roads (US Environmental Protection Agency interpretation).

**Site Preparation:** A forest activity to remove unwanted vegetation and other material, and to cultivate or prepare the soil for reforestation.

**Skid Trails:** A temporary pathway over forest soil to drag felled trees or logs to a landing.

**Slope:** Degree of deviation of a surface from the horizontal, measured as a numerical ratio, percent, or in degrees. Expressed as a ratio, the first number is the horizontal distance (run) and the second is the vertical distance (rise), as 2:1 (Horizontal: Vertical - H:V). A 2:1 slope is a 50 percent slope. Expressed in degrees, the slope is the angle from the horizontal plane, with a 90 degree slope being vertical (maximum) and 45 degrees being a 1:1 slope.

**Soil:** The unconsolidated mineral and organic material on the immediate surface of the earth that serves as a natural medium for the growth of land plants.

**Soil Conservation:** Using the soil within the limits of its physical characteristics and



protecting it from unalterable limitations of climate and topography.

**Soil Productivity:** The output or productive capability of a forest soil to grow timber crops.

**Standard Erosion and Sediment Control Plan (Standard Plan):** Authorized by COMAR 26.17.01.07.C. This regulation allows the adoption of erosion and sediment control plans for minor grading and earth disturbances. Forest harvest operations that meet the following criteria may obtain erosion and sediment control approval by completing an application at the local SCD office or other authorized agency's office:

- Road cuts and fills are 3 feet or less (5 feet in Garrett, Allegany, Washington, and Frederick counties);
- Grades for haul roads do not exceed 15 percent;
- Landings are located on slopes 10 percent or less;
- Grades for skid trails do not exceed 20 percent; and
- The site has no stream crossings.

**Stream:** A permanently or intermittently flowing body of water that follows a defined course.

**Stream Banks:** The usual boundaries, not the flood boundaries, of a stream channel. Right and left stream banks are named facing downstream.

**Streamside Management Zone (SMZ):** An area of 50 feet or more, based on steepness of adjacent slopes, on both banks of blue line streams. Requires extra precautions when carrying out forest harvests and protects stream banks and water quality. This designation was formerly known as buffer zone.

**Streamside Management Zone Plan (SMZ Plans):** A plan, prepared by a LPF, and requiring approval by the SCD, or other approval authority that allows harvesting within the SMZ. The plan must describe the harvest method, the square footage of basal area to be removed and retained, provisions for removing and restocking the cut trees, the BMPs to be implemented and maintained during the harvest, the location of skid trails, and any other criteria required by the SCD. Used in conjunction with the Standard Erosion and Sediment Control Plan or incorporated into the Custom Erosion and Sediment Control Plan.

**Switchback:** A 180 degree direction change in a trail or road used to climb steep slopes.

**Thermal Pollution:** A temperature rise in a body of water sufficient to be harmful to aquatic life.

**Tread:** Load bearing surface of a trail or road.

**Turnout:**

1. A drainage ditch that drains water away from roads.
2. A widened space in a road to allow vehicles to pass one another.

**Waste:** Materials and substances usually discarded as worthless to the user.

**Water Bar:** A diversion ditch and/or hump across a trail or road tied into the uphill side for the purpose of carrying water runoff into the vegetation, duff, ditch, or dispersion area so that

it does not gain the volume and velocity which causes soil movement and erosion of the road or trail.

**Water Quality:** A term used to describe the chemical, physical, and biological characteristics of water, usually with respect to its suitability for a particular purpose.

**Water Quality Standards:** Minimum requirements of purity of water for various uses; for example, water for agricultural use in irrigation systems should not exceed specific levels of sodium bicarbonate, pH, total dissolved salts, etc.

**Waters of the State (§4-101.1d, Environment Article, Annotated Code of Maryland):**

(1) Both surface and underground waters within the boundaries of this State subject to its jurisdiction, including that part of the Atlantic Ocean within the boundaries of this State, the Chesapeake Bay and its tributaries, and all ponds, lakes, rivers, streams, storm drain systems, public ditches, tax ditches, and public drainage systems within this State, other than those designed and used to collect, convey, or dispose of sanitary sewage; and

(2) The flood plain of free-flowing waters determined by the Department of Natural Resources on the basis of the 100-year flood frequency.

**Watercourse:** A defined channel with bed and banks within which concentrated water flows continuously or intermittently.

**Watershed Area:** All land and water within the confines of a drainage divide.

**Wetlands:** Geographic areas characteristically supporting hydrophytes, hydric soils and some saturation or flooding during the growing season.

# **APPENDICES**



## APPENDIX A FOREST HARVEST EROSION AND SEDIMENT CONTROL PLAN DECISION FLOW CHARTS

Use the following flow chart to aid in determining what type of Erosion and Control Plan is needed for a harvest activity. Enter the chart and answer True or False to the statement in each box according to specific site conditions and location and follow the path to a red box to determine the plan(s) required for your harvest site.

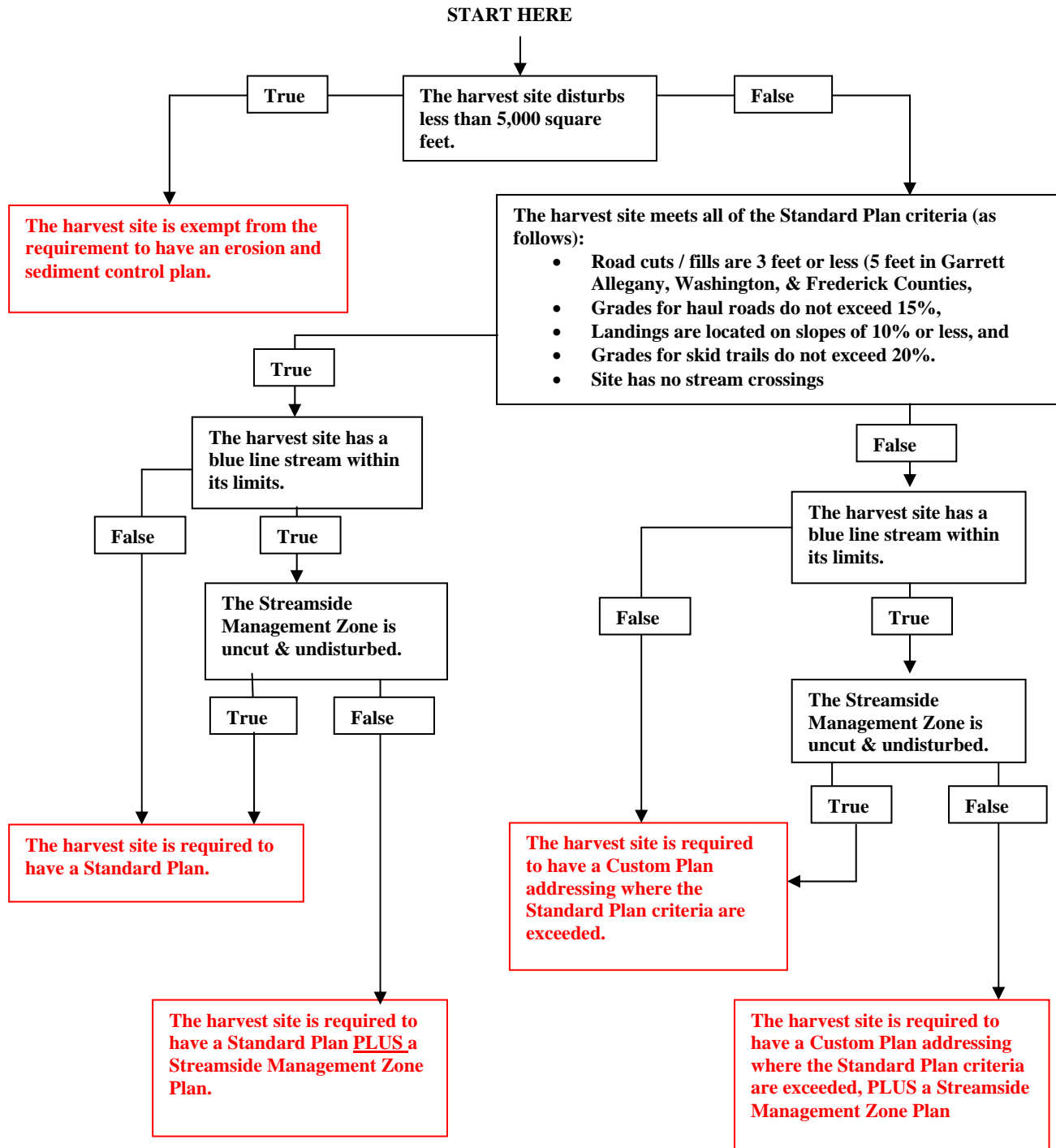

## **APPENDIX B**

### **EXAMPLES OF EROSION AND SEDIMENT CONTROL PLANS**

The following pages contain:

1. Example of a completed Standard Erosion and Sediment Control Plan (Standard Plan), showing the most basic plan; minimum width Streamside Management Zone (SMZ) and no cutting in the SMZ,
2. Example of a completed Standard Plan – Complex, showing wider SMZ, and no cutting in the SMZ,
3. Example of a SMZ Plan that can be used in conjunction with a Standard Plan,
4. Example of a Custom Erosion And Sediment Control Plan (Custom Plan) showing steep slope conditions and no cutting in the SMZ, and
5. Example of a Custom Plan showing grading and harvesting in the SMZ and waterway crossings.

These examples may serve as guidance in preparing your plans. Other formats are possible. Specific requirements as to content, use of locally produced forms, and number of copies may vary from one the SCD office to another. It is suggested that you check with your specific SCD.

## **APPENDIX B.1**

### **STANDARD PLAN – BASIC**

#### **Contents:**

- **Application**
- **Site Plan**
- **Location Map**
- **Topographic Map**

**STANDARD EROSION AND SEDIMENT CONTROL PLAN  
FOR FOREST HARVEST OPERATIONS**

**I. Site Information**

A. Location: Alpha Tract Bruceville Road - 2.5 miles from Rt. 408  
(Include Sketch or Map of Property)

B. Nature of Operation: Logging Acres harvested: 35 ac.  
(Logging including clearcut & damage select cut, Woodchipping, Firewood)

**II. Landowner and Operator Information**

Landowner: Leon Kensyl, III

Address: P.O. Box 7 Denton MD 21629

Phone: 555-555-1000 Email: KensylIII@yahoo.com

Operator: Ikom-Isaw Logging Company

Address: 5 Pinetree Way Denton MD

Phone: 555-555-1200 Email: isawlogging@yahoo.com

Current F.P.O. Lic. #: 475 Green card#: 23

1. List the names of other operators who may be involved in the harvest and the nature of their operations: None
2. If subcontracting to any of the operators listed above, do you assume responsibility for their compliance with this plan? Yes If no, they must obtain a separate plan prior to their operations.

**III. Agreement**

A. I / We agree to adhere to Standard Erosion and Sediment Control Plan for Forest Harvest Operations, and to grant inspectors the right of entry to the site to monitor compliance.

B. I am aware of the landowner's responsibility in preventing accelerated erosion and sedimentation during and subsequent to forest harvest operations as mandated by the rules and regulations adopted by the State of Maryland and local jurisdictions, and the *2015 Maryland Soil Erosion and Sediment Control Standards and Specifications for Forest Harvest Operations*.

C. I agree to require that all operators conducting forest harvest operations on my property to adhere to the requirements of the Standard Plan.

Landowner: Leon Kensyl III Date: 1/2/16

Operator: Barry Radcliff Date: 1/2/16

Approved: Augie Worm Date: 1/2/16  
Soil Conservation District

**SAMPLE PLAN ONLY**



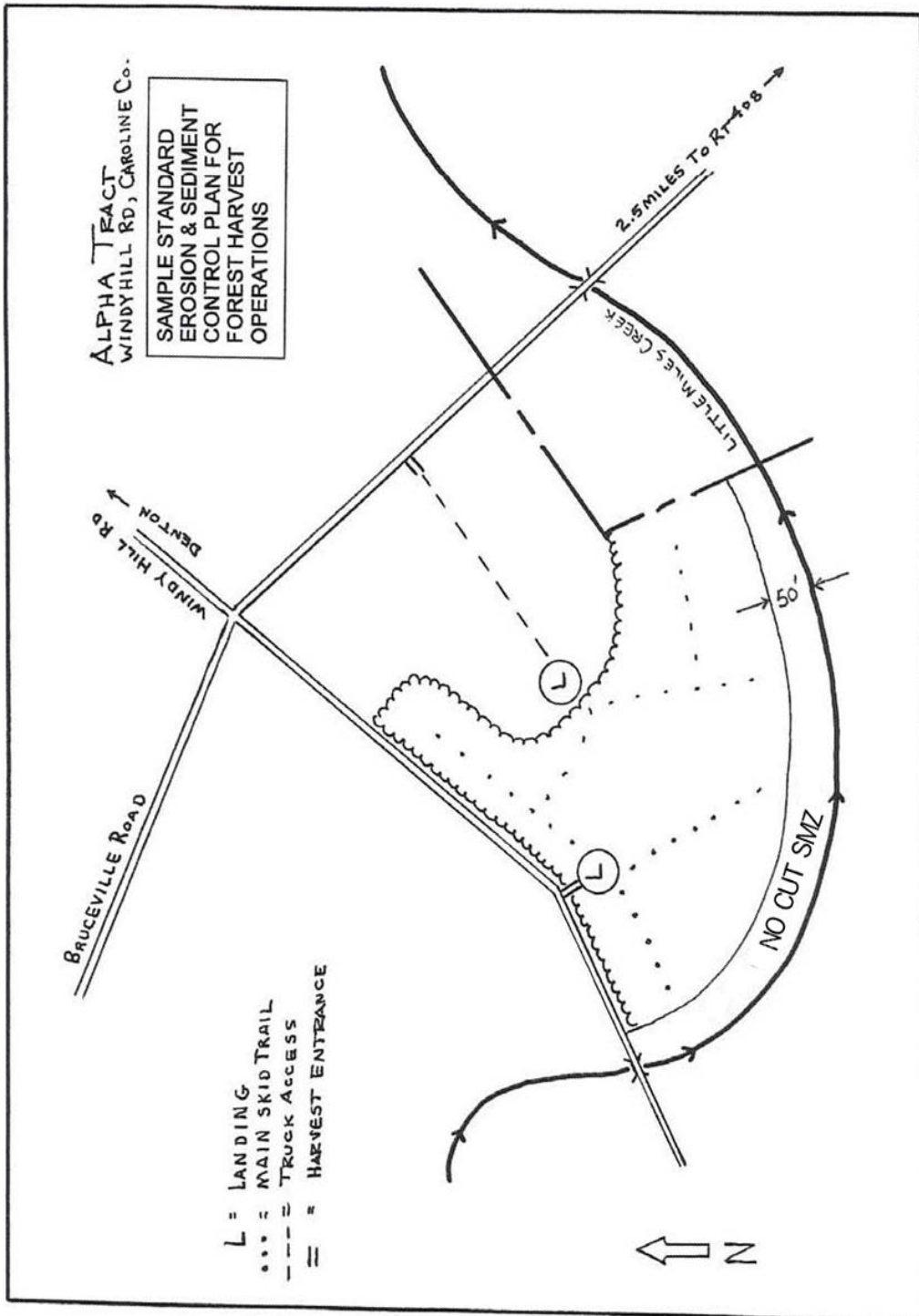

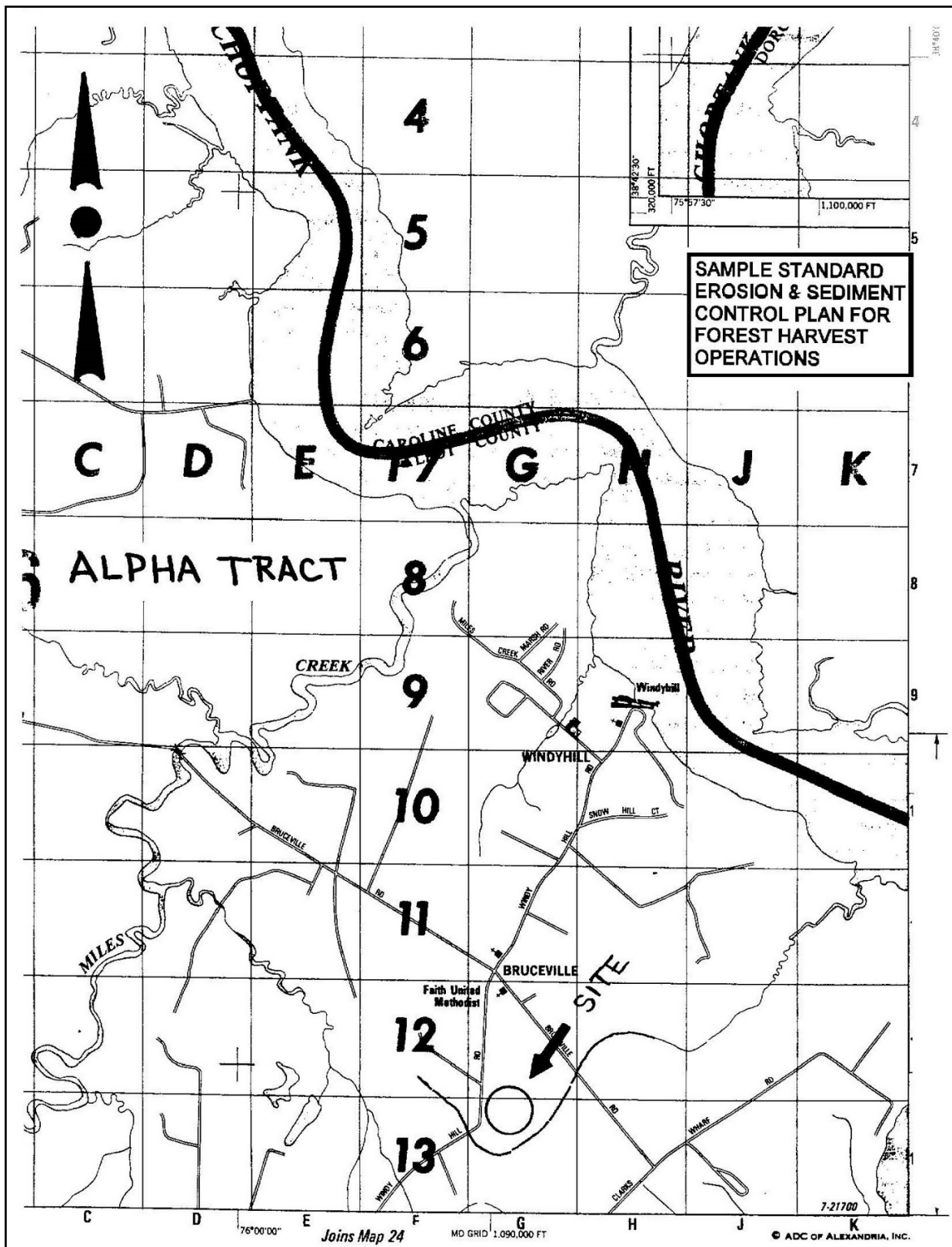

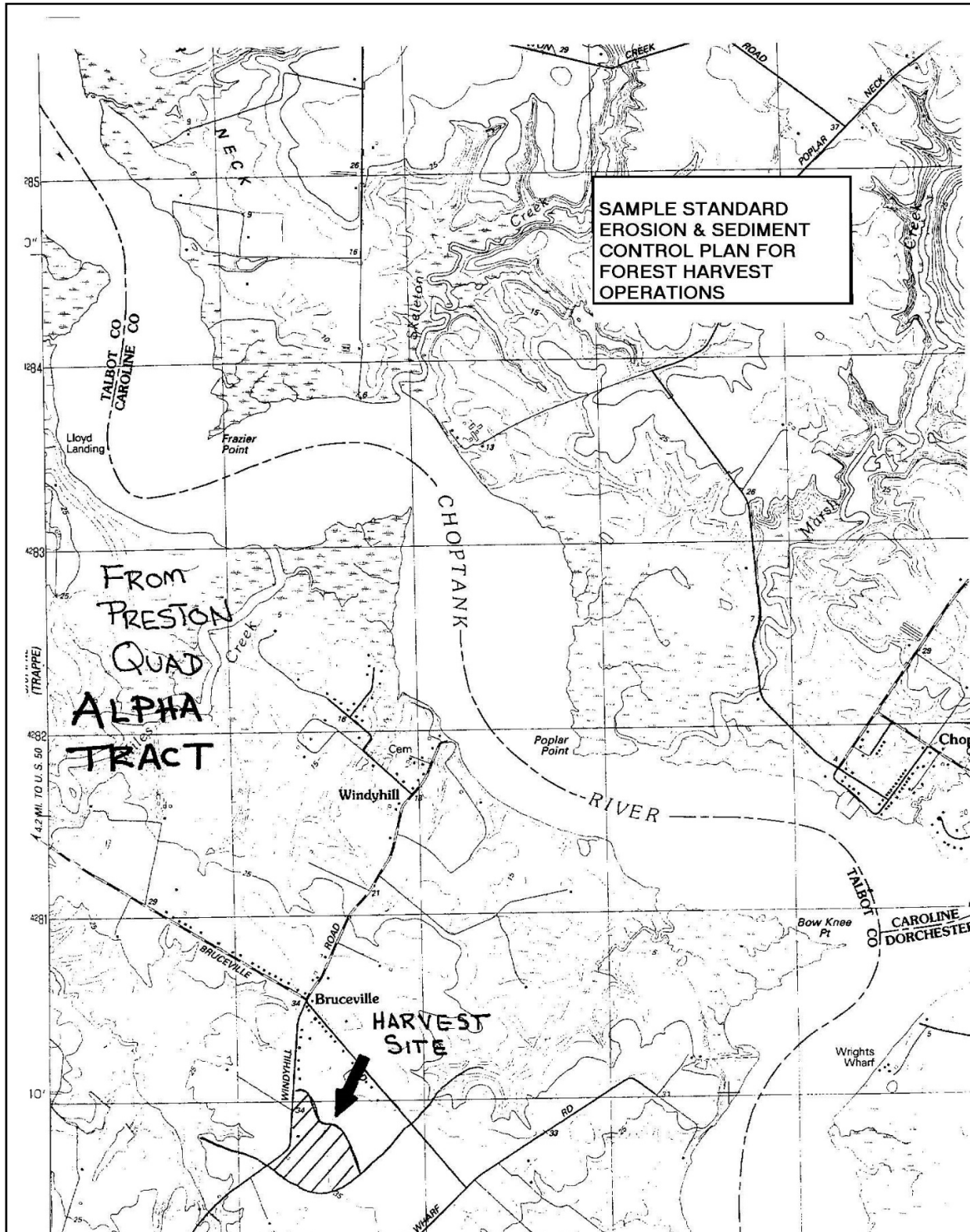

**APPENDIX B.2**  
**STANDARD PLAN – COMPLEX**

**Contents:**

- **Application**
- **Site Plan**
- **Location Map**
- **Topographic Map**

**STANDARD EROSION AND SEDIMENT CONTROL PLAN  
FOR FOREST HARVEST OPERATIONS**

**I. Site Information**

A. Location: Beta Tract 3715 Ironsides Rd - 4 miles west of Rt. 6  
(Include Sketch or Map of Property)

B. Nature of Operation: Logging/Firewood Acres harvested: 223 ac.  
(Logging including clearcut & damage select cut, Woodchipping, Firewood)

**II. Landowner and Operator Information**

Landowner: Ed Boardman

Address: 3715 Ironsides Rd Grayton, MD 21703

Phone: 555-555-1100 Email: \_\_\_\_\_

Operator: Ikom-Isaw Logging Company

Address: 5 Pinetree Way Denton MD

Phone: 555-555-1200 Email: isawlogging@yahoo.com

Current F.P.O. Lic. #: 475 Green card#: 23

1. List the names of other operators who may be involved in the harvest and the nature of their operations: None

2. If subcontracting to any of the operators listed above, do you assume responsibility for their compliance with this plan? Yes If no, they must obtain a separate plan prior to their operations.

**III. Agreement**

A. I / We agree to adhere to Standard Erosion and Sediment Control Plan for Forest Harvest Operations, and to grant inspectors the right of entry to the site to monitor compliance.

B. I am aware of the landowner's responsibility in preventing accelerated erosion and sedimentation during and subsequent to forest harvest operations as mandated by the rules and regulations adopted by the State of Maryland and local jurisdictions, and the *2015 Maryland Soil Erosion and Sediment Control Standards and Specifications for Forest Harvest Operations*.

C. I agree to require that all operators conducting forest harvest operations on my property to adhere to the requirements of the Standard Plan.

Landowner: Ed Boardman Date: 1/2/16

Operator: Barry Radcliff Date: 1/2/16

Approved: Augie Worm Date: 1/2/16  
Soil Conservation District

**SAMPLE PLAN ONLY**

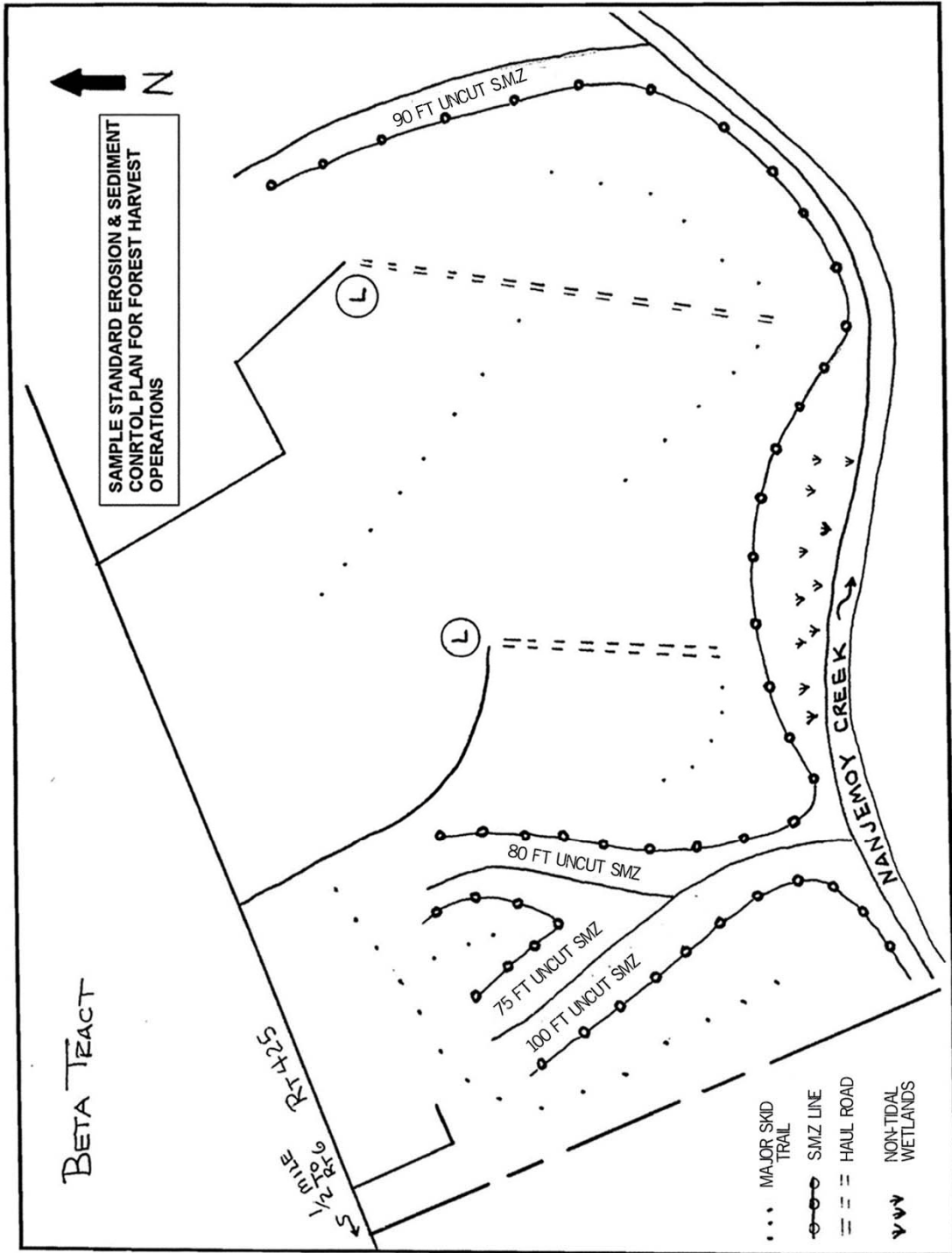

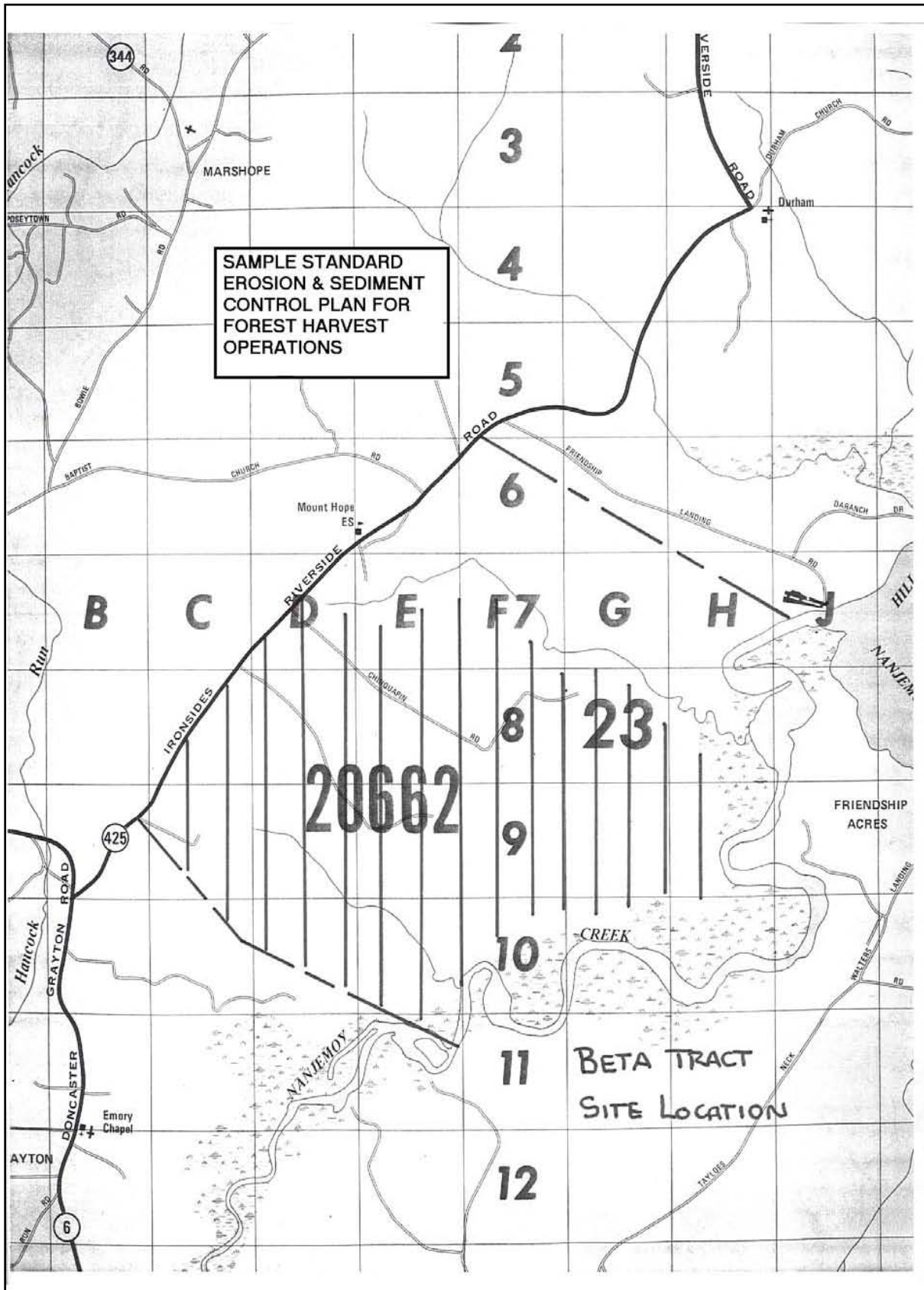



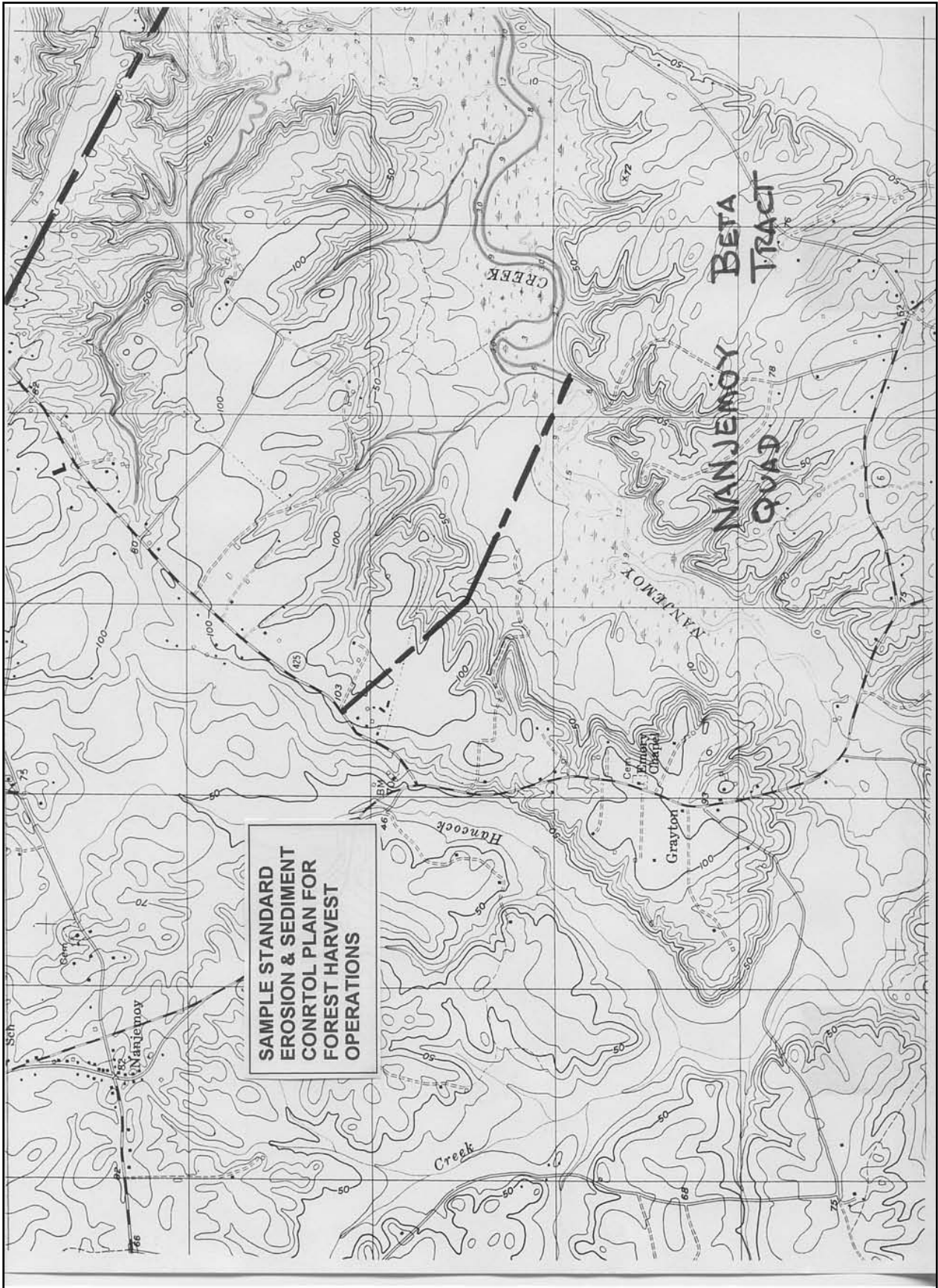



## **APPENDIX B.3**

### **Streamside Management Zone (SMZ) PLAN**

**Caroline Forestry Associates**

**ALPHA TRACT BRUCEVILLE ROAD CAROLINE COUNTY**

**NOTE: As presented here this SMZ Plan is intended to be used with the first Standard Plan (Alpha Tract) presented in this appendix.**

The Streamside Management Zone (SMZ) will be field marked with blue flagging. There are no existing roads in the SMZ and no new ones will be constructed. No skid trails are shown in the SMZ; only limited number of passes will be made through any one portion of the zone to avoid compacting the humus layer. Any disturbance or compaction will be repaired prior to leaving that section of the tract. Any earth disturbance throughout the tract will be stabilized within seven (7) days of the disturbance.

Timber to be cut in the SMZ will be marked at eye level and at the base of the stump in blue paint. Timber felled within the last 50 feet of the zone will be skidded out using only single-pass trails and skidding will cease before the humus layer is damaged.

Equipment will be serviced off site.

#### **Contents:**

- **SMZ Site Plan**

SAMPLE STREAMSIDE MANAGEMENT ZONE PLAN

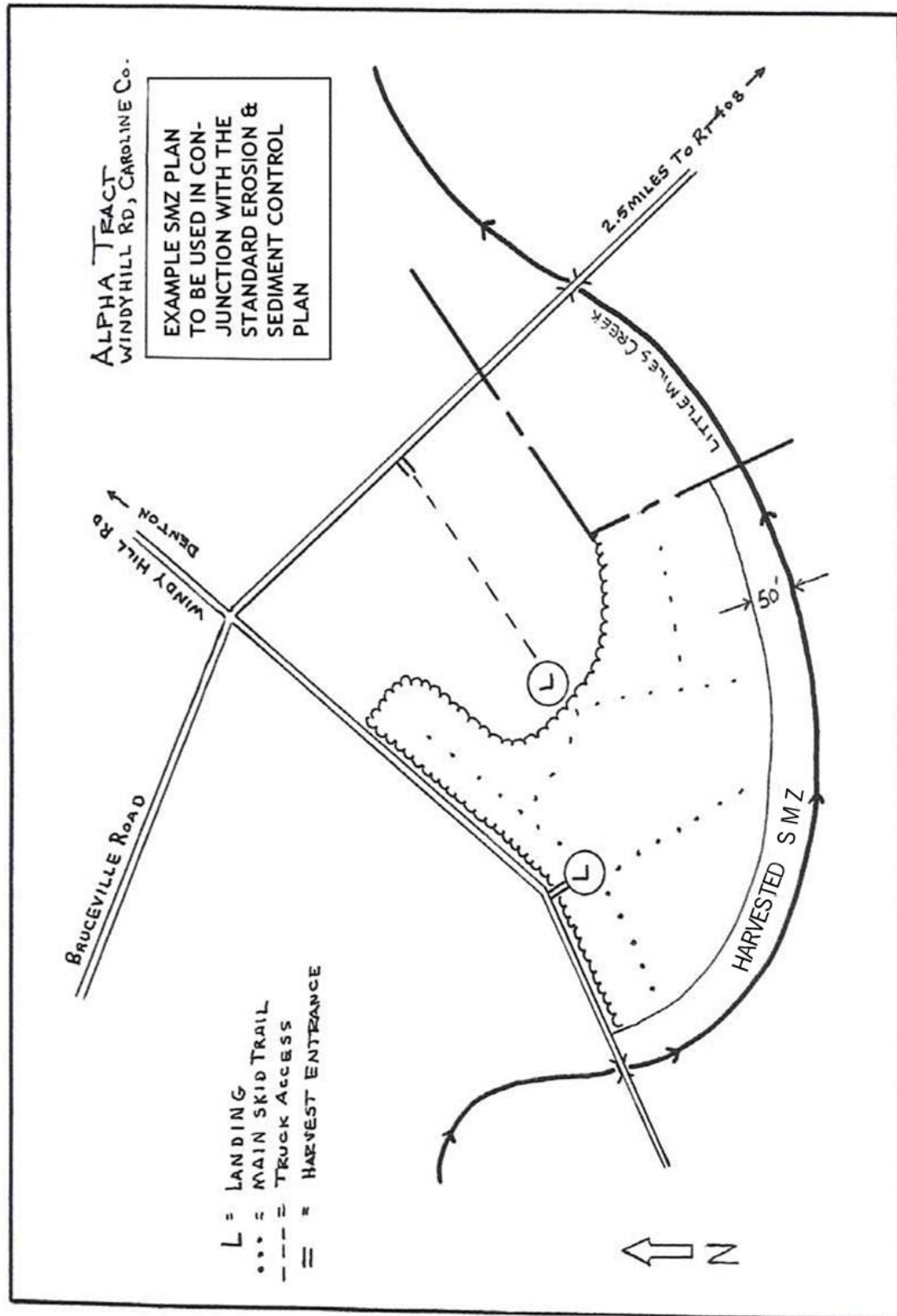

## **APPENDIX B.4**

### **CUSTOM PLAN – NO WORK IN THE SMZ**

#### **Contents:**

- **Plan Information**
- **Site Plan**
- **Location Map**
- **Topographic Map**

#### **Plan Information**

##### **FREDERICK FORESTRY ASSOCIATES**

Location: Delta Tract, 7500 Black Ankle Road; bounded by Talbot Branch to the north and Black Ankle and Buffalo Roads on the south.

Owner: Nathan Broadbeam, P. O. Box 8, Uniontown Maryland 21212

Erosion And Sediment Control Plan: This harvest will follow the criteria as set down in the Standard Erosion and Sediment Control Plan except for one section of skid trail that has a slope of approximately 25%. This trail is located on the western side of the tract, adjacent to Black Ankle Road. Turnouts will be installed along this trail every 50 feet. There will be no harvesting in the SMZ.

#### **SPECIFICATIONS FOR WATER TURNOUTS**

1. The turnout shall intersect the ditch line at an equal depth and be out-sloped 1 to 3 percent.
2. On sloping roads, the turnout shall be 30 degrees to 45 degrees downslope.
3. Turnouts shall be spaced to allow the roadbed to dry out and reduce the volume and velocity of side ditch waters.
4. Runoff water shall be spread at the outlet of the turnout.
5. Turnouts shall not feed directly into adjacent drainages or channels.

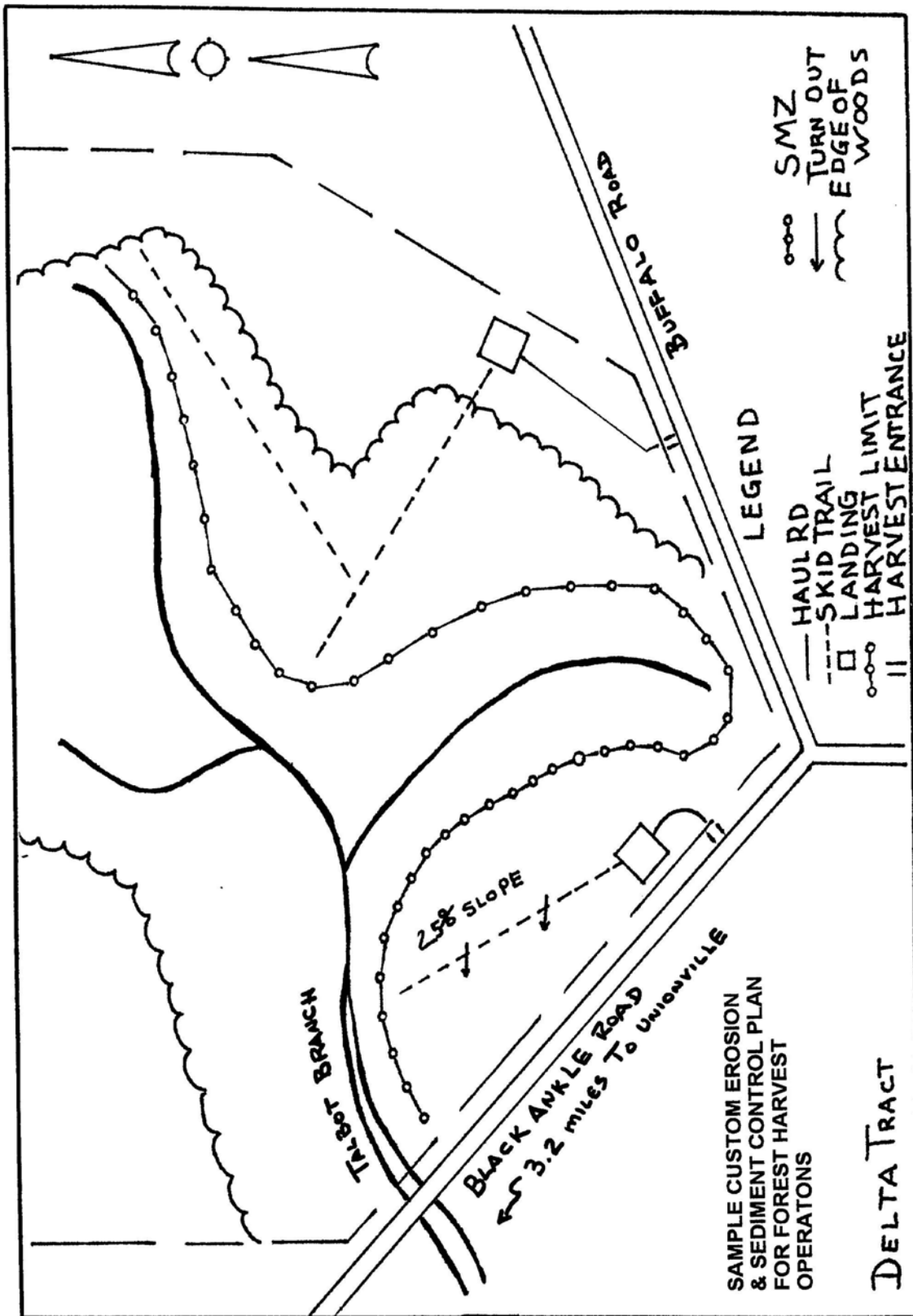

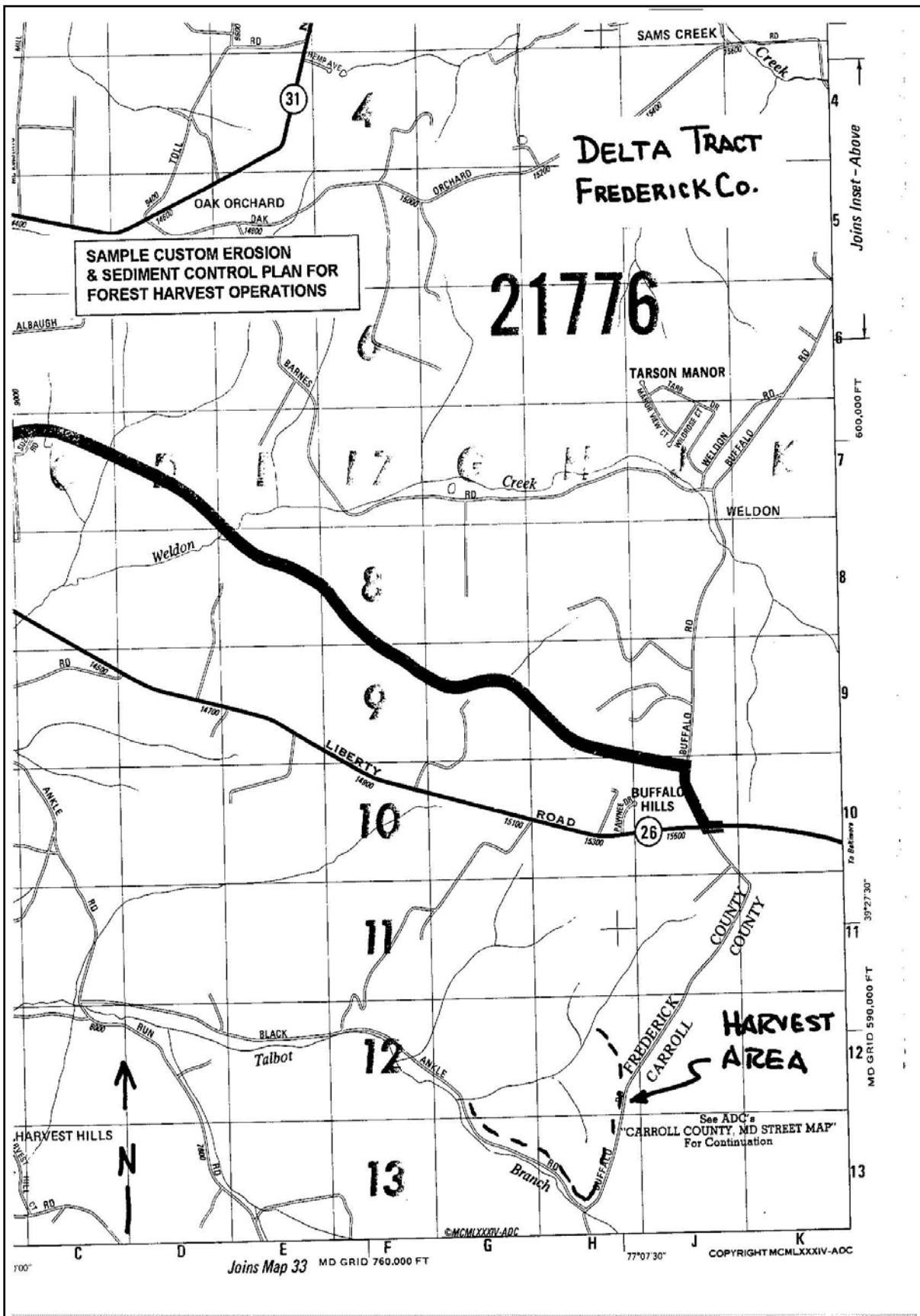



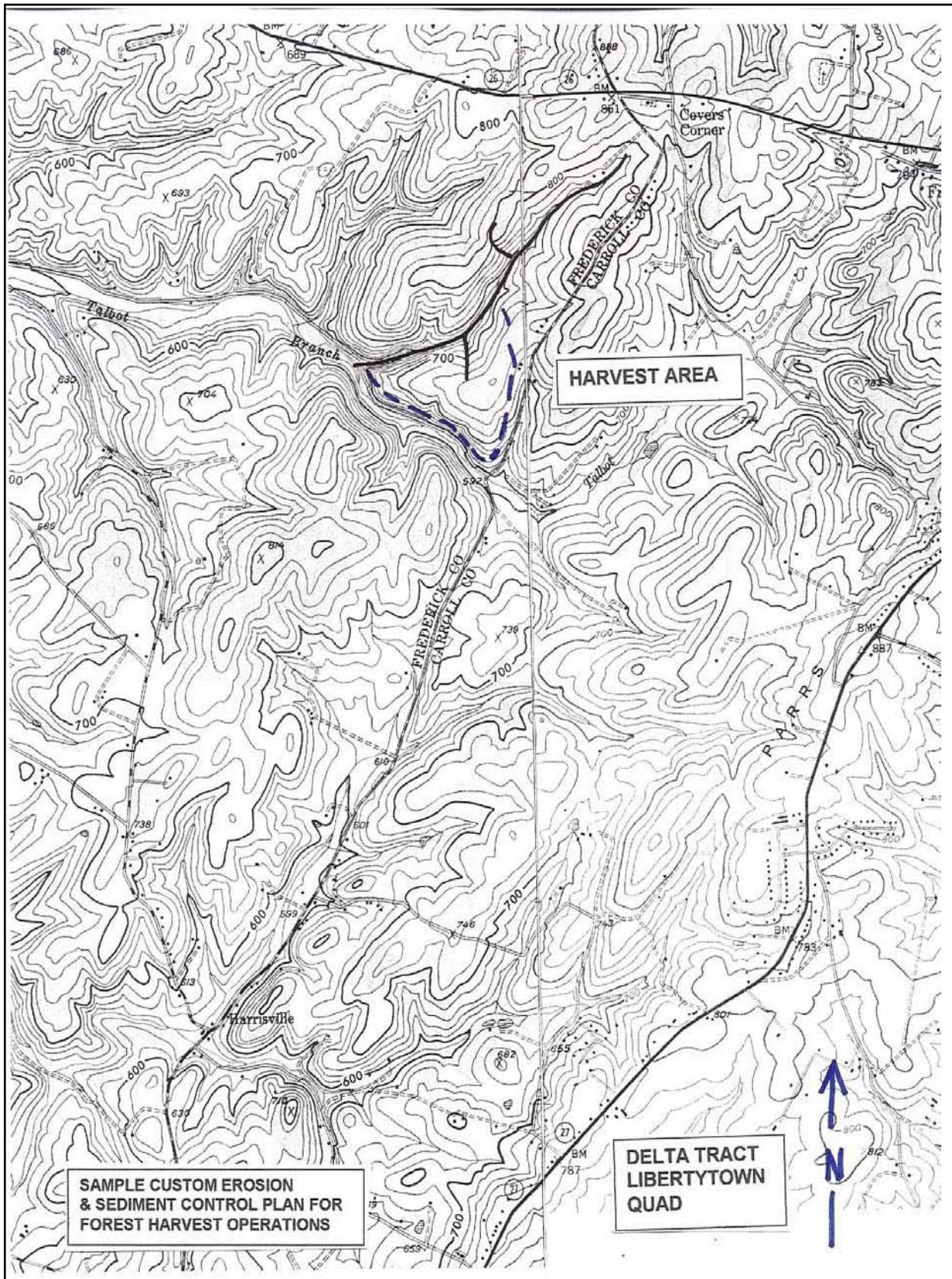

## APPENDIX B.5

### CUSTOM PLAN – INCLUDES SMZ ISSUES

#### Contents:

- **Plan Information**
- **Site Plan**
- **Location Map**
- **Topographic Map**

#### Plan Information

##### Allegany Forestry Associates

#### COLLIER TRACT WILLIAMS ROAD ALLEGANY COUNTY

This harvest will follow criteria as set down in the Standard Erosion and Sediment Control Plan, except that the harvest of this site includes:

1. Greater than a 5 foot cut on one skid trail,
2. Skid trails with approximately 25 percent slopes and
3. Harvesting in the Streamside Management Zone (SMZ).

Cut material will be graded out adjacent to the skid trail and stabilized in accordance with the standards and specifications. Turnouts will be installed every 50 feet along the skid trail where the slope exceeds 20 percent. In no case will the trail slope exceed 20 percent for more than 200 feet.

The SMZ will be field marked with blue flagging. There are no existing roads in the SMZ and no new ones will be constructed except to access two waterway crossings. No skid trails are shown in the SMZ; only a limited number of passes will be made through any one portion of the zone to avoid compacting the humus layer. Any disturbance or compaction will be repaired prior to leaving that section of the tract. Any earth disturbance throughout the tract will be stabilized within seven (7) days of the disturbance.

The haul road crossing of Collier Run Tributary will use a temporary bridge. The skid trail crossing will use culverts, following specifications in the 2015 Maryland Erosion and Sediment Control Standards and Specifications for Forest Harvest Operations. This crossing will require a permit from the MDE-WMA Wetlands and Waterways Program, for which applications have been made.

Timber to be cut in the SMZ will be marked at eye level and at the base of the stump in blue paint. Timber felled within 50 feet of the stream will be skidded out using single pass trails and skidding will cease before the humus layer is damaged.

Equipment will be serviced off site.

#### **Specifications For Turnouts**

1. The turnout shall intersect the ditch line at an equal depth and be out-sloped 1 to 3 percent.
2. On sloping roads, the turnout shall be 30 degrees to 45 degrees downslope.
3. Turnouts shall be spaced to allow the roadbed to dry out and reduce the volume and velocity of side ditch waters.
4. Runoff water shall be spread at the outlet of the turnout.
5. Turnouts shall not feed directly into adjacent drainages or channels.
6. Turnouts can be constructed of brush dams, earth dams, or flat spreader gaps.

#### **Specifications For Culverts**

1. The size of the culvert will be the largest pipe diameter that will fit into the existing channel without major excavation of the waterway channel. The invert elevation of the culvert will be installed on the natural streambed grade to minimize interference with fish migration.
2. The culverts will extend a minimum of 1 foot beyond the upstream and downstream toe of the aggregate placed around the culvert.
3. Non-woven geotextile shall be placed on the streambed and stream banks prior to placement of the pipe culvert and aggregate. The geotextile fabric shall cover the streambed and extend a minimum 6 inches and maximum 1 foot beyond the end of the culvert and bedding material.
4. The culverts will be covered with a minimum of 1 foot of washed aggregate.
5. All areas disturbed during culvert installation will be stabilized within 24 hours of the disturbance
6. After harvest, all structures, including the culvert, bedding and geotextile fabric materials, shall be removed within 14 calendar days.



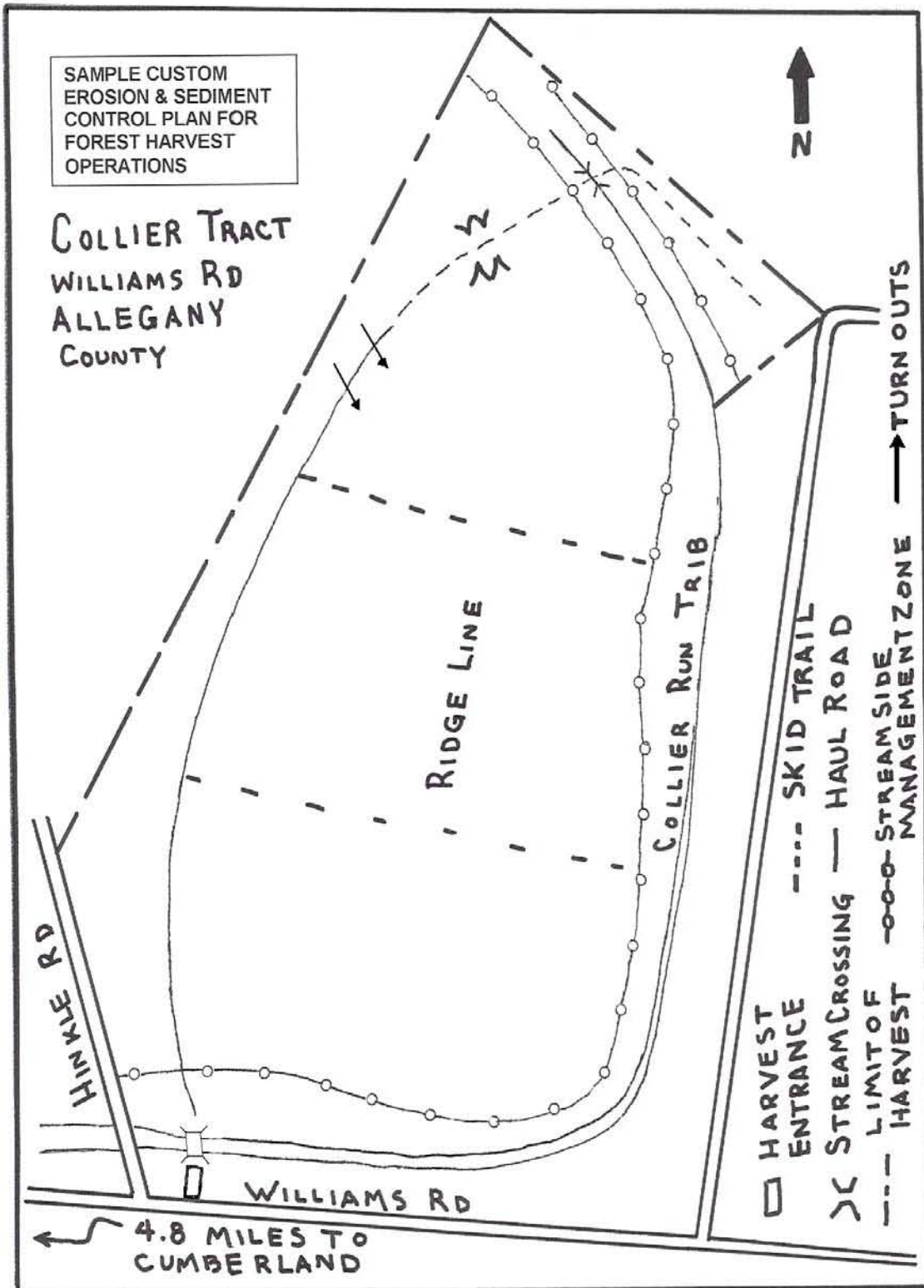



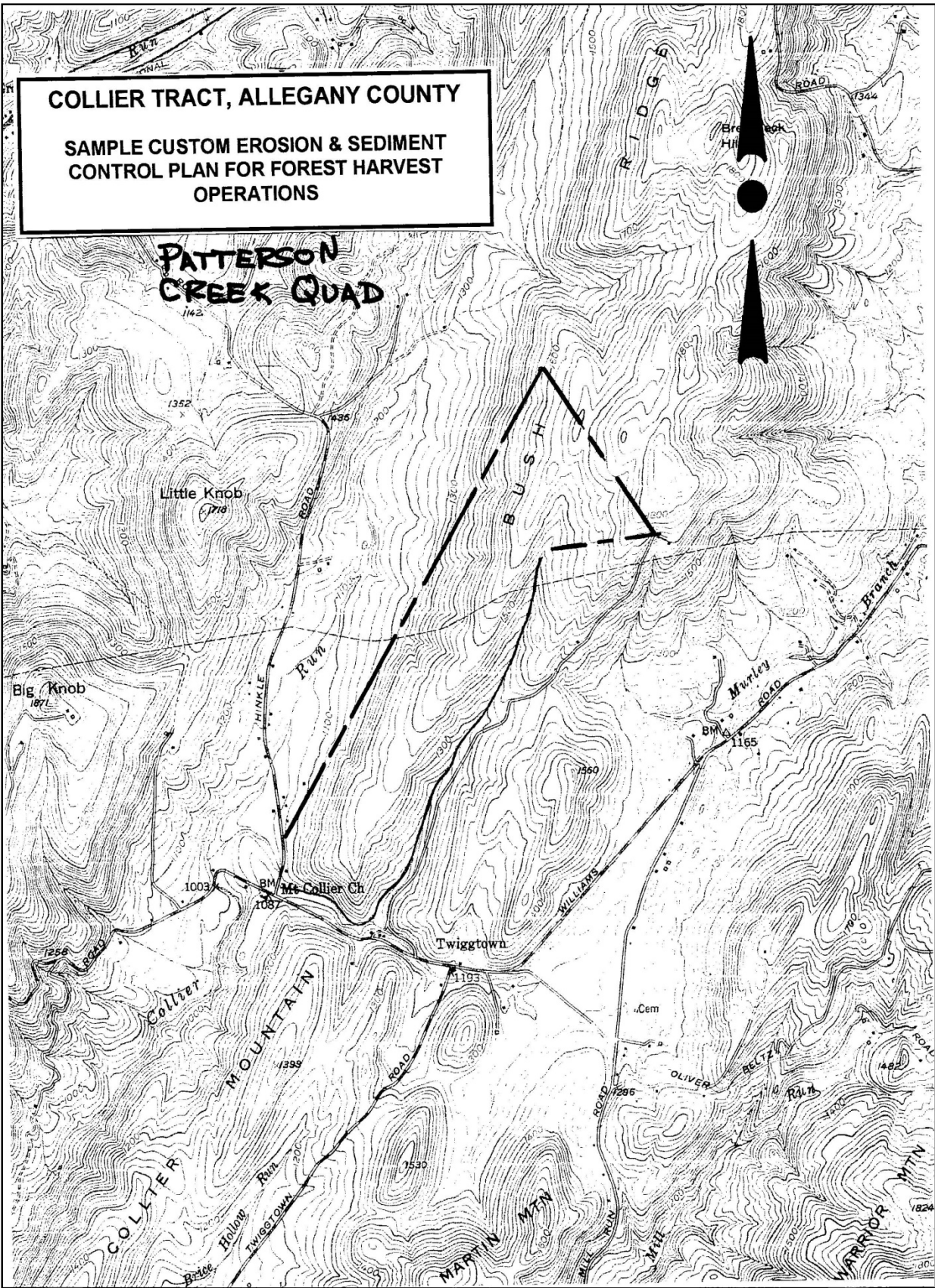



# APPENDIX C

## USDA CODE 342

NATURAL RESOURCES CONSERVATION SERVICE

CONSERVATION PRACTICE STANDARD

MARYLAND

CRITICAL AREA PLANTING

CODE 342

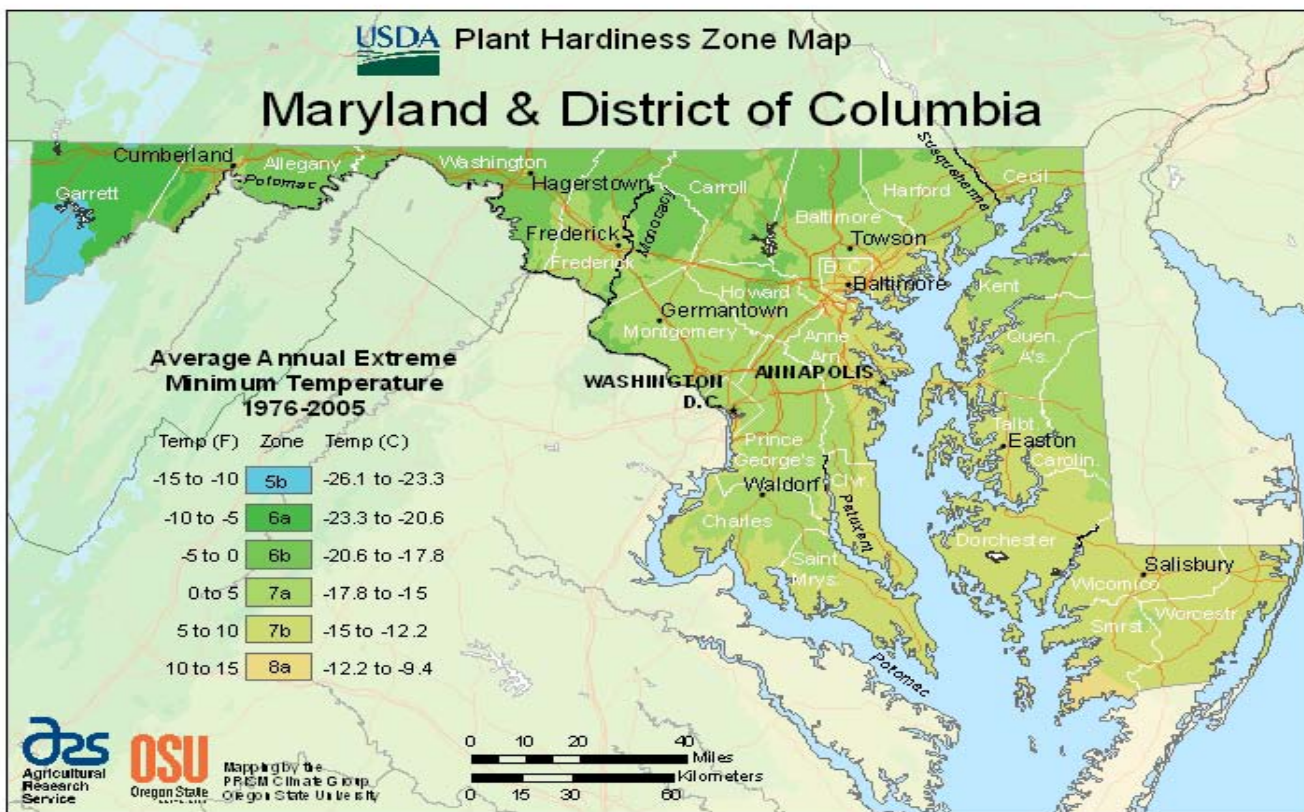



## DEFINITION

Establishing permanent vegetation on sites that have, or are expected to have, high erosion rates, and on sites that have physical, chemical or biological conditions that prevent the establishment of vegetation with normal practices.

### Purpose

- Stabilize stream and channel banks, and shorelines.
- Stabilize areas with existing or expected high rates of soil erosion by wind or water.
- Rehabilitate and revegetate degraded sites that cannot be stabilized using normal establishment techniques.
- Stabilize coastal areas, such as sand dunes and riparian areas.

## CONDITIONS WHERE PRACTICE APPLIES

This practice applies to all land uses where soil stabilization requires using specialized plant species and establishment methods. Examples of applicable areas include:

- active or abandoned mined lands;
- urban conservation sites;
- road construction areas;
- conservation practice construction sites;
- areas needing stabilization before or after natural disasters such as floods, hurricanes, tornados and wildfires;
- eroded banks of natural channels, banks of newly constructed channels, and lake shorelines; other areas degraded by human activities or natural events.

This practice does not apply to tree planting that is primarily intended for production of timber and other forest products. (Refer to the conservation practice standard for Tree/Shrub Establishment (612)

## CRITERIA

### General Criteria Applicable To All Purposes

**Grading Plan** - The grading plan and practice installation shall be based upon adequate topographic surveys and investigations. The plan shall show the location, slope, cut, fill, and finish elevation of the surfaces to be graded. The plan shall also include auxiliary practices for safe disposal of runoff water, slope stabilization, erosion control, and drainage. Practices such as waterways, ditches, diversions, grade stabilization structures, retaining walls and subsurface drains shall be included where necessary.

**Site Preparation** - Timber, logs, brush, rocks, stumps and vegetative matter that will interfere with the grading operation or affect the planned stability of fill areas shall be removed and disposed of according to the plan. Strip and stockpile topsoil in amounts necessary to complete finish grading of all exposed areas requiring topsoil. A minimum 4-inch stripping depth shall be used, depending on the particular soil.

Fill material shall be free of brush, rubbish, timber, logs, stumps, and other vegetative matter in amounts that is detrimental to constructing stable fills.

All disturbed areas shall be left with a generally smooth finish and shall be protected from erosion.

Include provisions to safely conduct surface water to storm drains or suitable watercourses and to prevent surface runoff from damaging cut faces and fill slopes. In areas having a high water table, provide subsurface drainage to intercept seepage that would adversely affect slope stability, building foundations, or create undesirable wetness.

Protect adjoining properties from sedimentation associated with excavation and filling operations.

Do not place fill material adjacent to the bank of a stream or channel, unless provisions are made to protect the hydraulic, biological, aesthetic and other environmental functions of the stream.

**Plant Materials** - Select plant species based on their adaptability to the environmental conditions present and to the planned land use. Herbaceous and/or woody plants may be appropriate. For best results, use species and varieties with proven conservation traits.

Species shall be selected based on:

1. Climatic conditions, such as annual and seasonal rainfall, growing season length, humidity, and USDA Plant Hardiness Zones (see Figure 1);
2. Soil and site conditions such as drainage class, pH, available water holding capacity, slope, aspect, shade, inherent fertility, salinity or alkalinity, flooding or ponding, and levels of toxic elements such as aluminum and heavy metals;
3. Plant characteristics, such as:
  - a. Ease of establishment, persistence, and time needed for full stand establishment;
  - b. Growth habit (e.g., sod or bunch) as it relates to surface cover;
  - c. Rooting depth and spread as it relates to slope stability;
  - d. Resistance to dislodgment by flowing water or wave action at various velocities and depths;
  - e. Season of growth (warm or cool) and life cycle (annual, perennial, or biennial);
  - f. Fertility and management requirements;
  - g. Visual appeal;
  - h. Suitability as wildlife food and/or cover.

Plant materials shall either be native to Maryland, or introduced and non-invasive (i.e., not likely to spread beyond the planted area and displace native species). When feasible, select locally native plant species and/or species that are beneficial to wildlife.

Site preparation and planting to establish vegetative cover shall be done at a time and manner to insure survival and growth of selected species. Provide supplemental moisture if and when necessary to assure early survival and establishment of selected species.

Only viable, high quality seed and planting stock shall be used. The method of planting shall include hand or machine planting techniques, suited to achieving proper depths and placement for the selected plant species.

Vegetation may be established by using seed, bare-root seedlings, containerized stock, or balled-and-burlapped stock. Younger planting stock is generally preferred to older stock because younger plants adapt more readily to new conditions.

Protect the planting from unacceptable impacts due to pests, wildlife, livestock, or fire. Exclude livestock as needed to establish the planting. Control noxious weeds as required by state law.

#### **Additional Criteria for Soil Amendments**

Use soil tests to determine the optimum recommendations for both lime and fertilizer. Soil analysis shall be performed by a soil testing laboratory that has been accredited by the North American Proficiency Testing Program, preferably the University of Maryland Soil Testing Laboratory. At a minimum, soil samples taken for nutrient and pH analysis shall be from the soil layer that will be used as the surface layer (top 4 to 6 inches) for seeding. Follow sampling procedures recommended by the laboratory.

**Lime** - Apply lime to achieve a soil pH of 6.0 if legumes are included in a planting, and 5.5 if only grasses or woody plants are used. Lime materials shall be ground agricultural limestone that contains at least 50% total oxides (calcium plus magnesium oxide). Hydrated lime may be substituted for agricultural lime, except in hydroseeding applications. Do not use burnt lime as a soil amendment.

Pulverized limestone shall be ground to such fineness that at least 50% will pass through a 100-mesh sieve and at least 98% will pass through a 20-mesh sieve. Apply pulverized limestone with a drop spreader when high winds will not interfere with uniform distribution of the material or cause nuisance dust. Pulverized limestone may also be used in a hydroseeding slurry.

Granular limestone shall be of such fineness that at least 30% will pass through a 100-mesh sieve, at least 50% through a 60-mesh sieve, and at least 98% through a 20-mesh sieve. Apply granular limestone with a drop or rotary spreader, but do not use it in a hydroseeding slurry.

Pelletized limestone, a product composed of pellets of pulverized limestone, shall be of a pellet type and size that is recommended by the manufacturer for use with turfgrass. The limestone used in the manufacture of the pelletized limestone product shall meet the minimum fineness requirements for pulverized limestone. Apply pelletized limestone with a drop or rotary spreader, or include it in a hydroseeding slurry.

When a soil test is not feasible, apply lime according to the rates specified as follows:

Soil Texture	Limestone Application Rate	
	Tons/acre	Lbs./ 1000 sq ft
Clay, clay loam and highly organic soil	3	135
Sandy loam, loam, silt loam	2	90
Loamy sand, sand	1	45

Limestone applied at rates greater than 50 pounds per 1,000 square feet (or greater than 1 ton per acre) shall be incorporated into the upper 4 to 6 inches of the soil. Limestone applied at lower rates may be incorporated or left on the soil surface.

***Fertilizer*** - The use of commercial fertilizer and other forms of plant nutrients must be in compliance with Maryland nutrient management regulations, as applicable. Apply fertilizer to prepared seedbeds, as needed based on soil test results. Fertilizer applied without a soil test may result in an inefficient quantity of nutrients for plant establishment, or could result in overapplication of nutrients leading to potential water quality problems and excessive weed growth. However, in circumstances when obtaining a soil test is not feasible, and a site is likely to have low nutrient levels, use the following rates for fertilizer applications:

1. Cool-season grass: 500 pounds per acre (or 10 pounds per 1,000 square feet) of 10-20-20 or equivalent;
2. Cool-season grass + legume: 500 pounds per acre (or 10 pounds per 1,000 square feet) of 5-20-20 or equivalent;
3. Warm-season grass or warm-season/ cool-season grass mixes: 500 pounds per acre (or 10 pounds per 1,000 square feet) of 0-10-10 or equivalent. Nitrogen is generally not

recommended for use during the establishment of warm-season grass because it encourages increased weed competition.

However, on sites with very low fertility and minimal likelihood of weed competition, 30 pounds per acre (0.7 pound per 1,000 square feet) of slow-release N may be applied at the time of planting, or 40 pounds per acre (1 pound per 1,000 square feet) of soluble N after grass emergence.

4. Warm-season grass + legume, or warm-season/cool-season grass mixes + legumes: 500 pounds per acre (or 10 pounds per 1,000 square feet) of 0-10-10 or equivalent. On very low fertility sites where there is minimal weed competition, apply 20 pounds per acre (0.5 pound per 1,000 square feet) of N after emergence.

All fertilizer shall be uniform in composition, free-flowing, and suitable for application by approved equipment. Fertilizers shall be delivered to the site fully labelled according to applicable state fertilizer laws, and shall bear the name, trade name, or trademark and warranty of the producer. When feasible, use slow-release forms of nitrogen to provide nitrogen over a longer period of time, and to reduce nitrogen leaching and runoff.

***Organic Amendments*** - Apply manure and compost at a rate based on a nutrient analysis of that material. Organic amendments to sites shall be recommended only after an evaluation of any potential water quality hazards. To the extent practical, incorporate organic amendments into the upper 4 to 6 inches of the soil with a disk, springtooth harrow, or other suitable equipment

**Additional Criteria for Topsoil**

Topsoil shall be added to a site when needed to improve the soil medium for plant establishment and growth. The use of topsoil shall be limited to slopes that are 2:1 or flatter.

Exposed soils shall be topsoiled if they have one or more of the following limiting factors:

1. Very shallow to bedrock or other restrictive layer (e.g., the subsoil is less than 6 inches deep);
2. Extremely acidic (pH less than 5.0); or,



3. Extremely salty (conductivity greater than 500 parts per million, or 4.0 millisiemens per centimeter).

Topsoil may also be used when assurance of improved vegetative growth is desired.

**Topsoil Quality** - Topsoil shall be friable and loamy, free of debris, stones, or other materials larger than 1.5 inches in diameter. It shall be free of any known viable seeds or plant parts of objectionable weeds such as Johnsongrass, shattercane, thistle, multiflora rose, or others as specified.

Topsoil shall contain no toxic substance that may be harmful to plant growth. Soluble salts shall not be excessive (concentration greater than 500 parts per million). A pH range of 5.5 to 7.5 is required. If pH is less than 5.5, lime shall be applied and incorporated with the topsoil to adjust the pH to between 5.5 and 7.5. A pH of 6.5 is ideal. Topsoil hauled in from off-site shall have a minimum organic matter content of 1% by weight, based on soil test results.

**Topsoil Application** - Before topsoiling, test the pH of the exposed subsoil. If the subsoil is highly acidic, add ground agricultural limestone at the rate of 4 to 8 tons per acre (200 to 400 pounds per 1,000 square feet). Distribute the lime uniformly, and work it into the subsoil as previously described in the section concerning Soil Amendments.

Immediately before spreading topsoil, the subsoil shall be loosened by disking or scarifying to provide a good bond for the topsoil. Where the slope of the site is flatter than 3:1, loosen the subsoil to a minimum average depth of 2 inches. On steeper slopes (up to 2:1), loosen the subsoil to a depth of 0.5 to 1 inch, or use a bulldozer to track up and down slope to create horizontal check slots that will prevent topsoil from sliding down the slope.

Topsoil shall only be handled when it is dry enough to work (less than field capacity) without damaging soil structure. Do not spread topsoil when it is partly frozen or muddy, or on frozen slopes covered with ice or snow.

Topsoil shall be uniformly applied in a 5 to 8 inch layer, and lightly compacted to a minimum thickness of 4 inches. Subsoil with a pH of 4.0 or less, or containing iron sulfide, shall be covered with a

minimum depth of 12 inches of topsoil.

Topsoil placed on slopes greater than 5% shall be promptly limed and fertilized (if needed), seeded, mulched, and tracked with suitable equipment.

#### **Additional Criteria for Seedbed Preparation**

Seedbed preparation shall be done when the soil is moist, but not wet. Lime, fertilizer, and other soil amendments shall be evenly applied where needed on the site, as described in previous sections of this standard. Either dry or wet application methods may be suitable.

**Slopes flatter than 3:1** - Seedbed preparation shall consist of working the soil to a depth of 3 to 5 inches with a disk or similar equipment. Continue tillage until a reasonably uniform seedbed is prepared.

**Slopes 3:1 or steeper** - Scarify the soil surface with a bulldozer, heavy chain, hand tools or other equipment that will loosen the soil 0.5 to 1 inch deep. After the soil is loosened, do not work it completely smooth, but leave it in a somewhat roughened condition. Follow the general contour when making the final surface preparation.

#### **Additional Criteria for Seed Quality and Treatment**

All seed shall be labeled and meet the requirements of the Maryland State Seed Law. Refer to Table 5 for minimum germination and purity requirements. Seed shall have had a germination test within 12 months prior to the date of sowing. Use of certified seed is preferred. Keep seed cool and dry until planting.

Species with seed lots greater than 50% hard seed shall be dehulled and/or scarified and planted no later than 60 days after scarification.

Grasses that have fluffy seeds shall be planted using specially designed native seed drills. Alternatively, mechanically remove beards or awns from such seeds to facilitate movement through conventional seeding equipment.

Legume seeds shall be inoculated with the proper, viable *Rhizobium* bacteria before planting. Keep inoculant as cool as possible until use, and do not use it later than the date indicated on the package.

When hydroseeding, use four times the recommended inoculant rate.

### **Additional Criteria for Seeding Operations**

Seed shall be applied uniformly by hand, cyclone seeder, drill, cultipacker-seeder, or hydroseeder. The preferred method of seeding is by drilling or cultipacker-seeder method because these methods optimize seed to soil contact.

Seeding operations shall be done on the contour to the extent feasible. When a uniform distribution of seed is especially important (e.g., on lawns and athletic fields) and slopes are not extremely steep, apply seed in two directions, each perpendicular to one another. Apply one-half the seeding rate in each direction.

**Drill** - Seed shall be planted by using a grass drill or cultipacker-type seeder. A grain drill may also be used if it can be calibrated to plant small seeds at the recommended planting rates. As noted above, plant grasses with fluffy seeds by using a specially designed native seed drill. All drills shall have packer wheels, chains, or similar devices to close the seed slot and provide good seed to soil contact. Do not plant small-seeded grasses more than 1/4 to 1/2-inch deep.

**Broadcast** - Seed may be broadcast by using a cyclone or whirlwind seeder, or by hand. If spread by hand, small or light-seeded species such as redtop or bluestem may be mixed with filler (e.g., sawdust, finely ground corn, or slightly moistened peat moss) to achieve an even distribution. Incorporate seed into the soil 1/8 to 1/4-inch deep by raking or dragging, cultipacking, or tracking with heavy machinery. Raked areas shall be rolled with a weighted roller to provide good seed to soil contact. Do not use broadcast seeding methods during windy conditions.

**Hydroseeding** - This method is best suited for steep, inaccessible areas where use of a drill or other mechanized equipment is not feasible. Hydroseeding shall be done in two separate operations with seed and fertilizer applied in the first pass, and mulch applied in the second pass. Do not use burnt or hydrated lime when hydroseeding. If legume inoculant is used, complete the seeding within 3 to 4 hours after slurry is mixed, or add a fresh supply of inoculant to the mix. If possible after seeding, track the area up and down slope with heavy machinery such as a bulldozer to

improve seed to soil contact.

### **Additional Criteria for Temporary Seeding and Nurse Crops**

When the period of soil exposure is more than two months but less than twelve months, a temporary seeding (usually an annual grass) shall be used to provide short-term cover on disturbed areas. See Table 1 for recommended plant species and planting rates.

Temporary seedings shall be planted as a nurse crop with a permanent seeding mixture when rapidly growing cover is needed. When seeding toward the end of the listed planting dates for permanent seedings, or when conditions are expected to be less than optimal, select an appropriate nurse crop from Table 1 and plant with the permanent seeding mix. Companion seedings of small-seeded grasses shall not exceed 5% (by weight) of the overall permanent seeding mixture. Companion seedings of small grains such as barley, wheat, or oats shall be sown at one-third the rates listed in Table 1. Cereal rye generally should not be used as a nurse crop, unless planting will occur in very late fall beyond the seeding dates for other temporary seedings. Cereal rye has allelopathic properties that inhibit the germination and growth of other plants.

Oats are the recommended nurse crop for warm-season grasses.

When a temporary or permanent seeding cannot be completed because of weather conditions or time of year, apply mulch only (no seeding) as a temporary cover when soil stabilization is needed. Refer to the Mulching section of this standard for application rates and methods.

### **Additional Criteria for Permanent Seeding**

Permanent herbaceous vegetation shall be designed to achieve a minimum stand density of 85 percent ground cover within one year.

**Seed Mixes** - To establish permanent cover, select grass and legume mixes according to the guidelines listed in Tables 3 and 4.

**Planting Dates** - Use Figure 1 and Table 2 to determine the recommended planting dates for selected mixes.

**Supplemental Watering** - If soil moisture is deficient, supply new seedlings with adequate water (a minimum of 1/4-inch twice a day) until vegetation is well established. This is especially necessary when seedlings are made in abnormally dry or hot weather or on droughty soils.

### **Additional Criteria for Mulching**

Mulch shall consist of natural and/or artificial non-toxic materials, such as coconut fibers, wood shavings, straw, hay, bark chips, plastic, or fabric of sufficient thickness and durability to achieve the intended effect for the required time period. Tackifiers, emulsions, netting, pinning, or other methods of anchoring mulch shall be sufficiently durable to maintain mulch in place until it is no longer needed.

Mulching is required for critical area plantings on structural measures (e.g., grassed waterways, diversions, embankments, etc.), and shall be applied elsewhere as needed to accomplish one or more of the following purposes:

1. To provide temporary erosion control when planting must be delayed until the proper planting dates, or until plantings become well established;
2. To conserve soil moisture and to aid seed germination and plant survival;
3. To reduce soil temperature fluctuations and frost heaving;
4. To reduce weed growth in planted areas;
5. To reduce surface compaction or crusting, and improve water infiltration.

Mulching may not be needed when critical area plantings are used on field borders, filter strips, highly erodible cropland, and similar areas where crop residue and/or nurse crops will provide sufficient cover after planting.

**Soil Stabilization Matting** - Biodegradable matting shall be used as needed to provide temporary erosion control until seedlings or other plantings become well established. These materials are especially applicable where high water velocities are expected.

Matting shall have a uniform thickness and distribution of natural or other biodegradable synthetic fibers or cords that freely allow penetration by water and plant seedlings. The materials shall resist decay for a minimum of 6 months, and shall not contain any harmful chemicals or other materials that may leach into the soil, or reduce the germination and establishment of seedlings.

Biodegradable matting shall be applied on seeded areas and shall be secured to the soil surface according to the manufacturer's instructions.

Permanent geotextiles (non-biodegradable) may also be used where long-term erosion control is needed. These materials shall also be installed according to the manufacturer's instructions.

**Straw or Hay Mulch** - Straw or hay shall be applied at the rate of 2 tons per acre (90 pounds per 1,000 square feet) immediately following seeding. Straw and hay shall be unweathered and free of any known viable seeds of objectionable weeds such as Johnsongrass, shattercane, thistle, or others as specified.

Spread mulch uniformly by hand or by mechanical methods so that approximately 85% of the soil surface is covered. This will provide erosion protection and allow adequate light penetration for seedling germination. Straw or hay shall not be chopped or finely broken during application.

On sites where mulch is exposed to displacement by wind and water, it shall be anchored immediately after placement. Use one of the following methods, depending on the size of the area, steepness of slope, and costs:

1. **Mulch Netting**. Cover mulch with degradable plastic, jute, or cotton netting. Staple the netting in place using wire staples;
2. **Crimper**. Use a tractor-drawn mulch anchoring coultter (crimper) to cut mulch into the soil surface, so as to anchor part of the mulch and leave part standing upright. Follow the general contours of the site when crimping mulch. Crimping operations are limited to areas accessible by tractor;

3. Liquid Mulch-Binders. Use one of the following:
- a. Organic and Vegetable-Based Binders. Mix with water and apply to mulch to form an insoluble polymer gel binder. Use at rates and under weather conditions as recommended by the manufacturer. These mulch binders shall be physiologically harmless and not impede the germination and growth of desired vegetation;
  - b. Synthetic Binders. Mix with water and apply to mulch to form an insoluble high polymer synthetic binder. Use at rates and under weather conditions as recommended by the manufacturer.

**Wood Fiber or Paper Fiber Mulch** - Mulch made from wood, paper, or plant fibers shall be applied at the rate of 2,000 pounds per acre, or as recommended by the product manufacturer. Mulch shall not contain any germination or growth inhibiting materials. It may be applied by hydroseeder, but shall not be mixed in the tank with seed. Use shall be limited to flatter slopes and during optimum seeding periods in the spring and fall. Do not use on steep slopes or in concentrated flow areas.

**Pelletized Mulch** - Dry pellets of compressed and extruded paper and/or wood fiber products shall be applied by hand or mechanical spreader at the rate of 60 to 75 pounds per 1,000 square feet, in accordance with the manufacturer's recommendations. Pelletized mulch may contain co-polymers, tackifiers, fertilizers, and coloring agents. Apply 1/4 to 1/2-inch of water after spreading pelletized mulch to activate and expand the mulch and to provide sufficient soil coverage. This mulch material is especially applicable for small lawns or renovation areas where weed-free mulch is desirable, or straw mulch and tackifiers are not practical.

**Bark Mulch** - Shredded or chipped hardwood bark or pine bark mulch shall be applied to a depth of 2 to 3 inches around plantings of trees, shrubs, groundcovers, and vines. Pine bark mulch generally decomposes more slowly and is less toxic to plants than hardwood bark mulch.

Shredded bark and bark chips ("nuggets") shall be well-aged, and applied to provide at least 85% ground cover. A minimum 3-foot diameter circle of mulch is recommended around each tree or shrub.

Do not mulch within 3 inches of the trunk. On steep slopes, use shredded bark mulch, rather than chips, because it is less subject to movement by water.

#### **Additional Criteria for Sod**

**Sod Quality and Treatment** - Sod used shall be state certified sod which is at least one year old but not older than 3 years. Commonly available sod types include Kentucky Bluegrass blends, and Tall Fescue/Kentucky Bluegrass mixes.

Sod shall be machine cut to uniform thickness of 3/4-inch, plus or minus 1/4-inch, at the time of cutting. Measurement of thickness shall exclude top growth or thatch.

Standard size sections of sod shall be strong enough to support their own weight and retain their shape when suspended vertically with a firm grasp of the upper 10% of the section.

Individual pieces of sod shall be cut to the supplier's width and length. Maximum allowable deviation from standard widths and lengths shall be no more than 5%.

Sod shall be harvested, delivered, and installed within a period of 36 hours. Sod not transplanted within this period shall be inspected and approved prior to its installation.

Do not harvest or transplant sod when the moisture content (excessively wet or dry) may adversely affect its survival.

**Planting Dates** - Use Figure 1 and Table 2 to determine the appropriate planting dates for sod.

The optimum planting period is in early fall, followed by the spring planting period. Sod may be planted during the summer if supplemental watering will be provided until the sod is well established. The fall planting season is limited by the amount of time the sod has to develop roots before the ground freezes. Newly sodded areas usually need 4 to 6 weeks before the sod is sufficiently rooted. Similarly, the spring planting season is limited by the high temperatures and drought of summer, unless supplemental water will be provided.

**Installation** - Prior to sodding, the soil surface shall be cleared of roots, brush, trash, debris, and other objects that would interfere with planting.

Based on a soil test, apply lime and fertilizer as needed, and mix into the top 3 inches of soil. Then rake the site smooth in preparation for laying sod.

During periods of high temperature, lightly water the soil surface immediately before laying the sod. Lay sod strips lengthwise on the contour, never up and down the slope, starting at the bottom of the slope and working up. On steep slopes, use ladders to facilitate the work and prevent damage to the sod.

Lay sod strips in staggered rows, with joints butted tightly together to prevent voids. Roll or tamp the sod immediately following placement to insure solid contact of root mat and soil surface. Do not overlap the sod strips.

On slopes greater than 3:1, secure sod to the soil surface with wooden pegs or wire staples.

Where surface water cannot be diverted from flowing over the face of a sodded slope, install a capping strip of heavy jute or plastic netting, properly secured, along the crown of the slope and edges to provide extra protection against lifting and undercutting of sod. Use the same technique to anchor sod in water-carrying channels and other critical areas. Use wire staples to anchor netting in channel work.

**Supplemental Watering** - Immediately following installation, sod shall be watered until moisture penetrates the soil layer beneath the sod to a depth of 4 inches. Maintain optimum moisture for at least 2 weeks by lightly watering the sod on a regular (usually daily) basis, unless sufficient rainfall has occurred. Do not allow the sod to dry out completely. After the sod begins to take root, reduce the frequency of watering and increase the amount of water applied per watering. This encourages the development of a deep root system and ultimately reduces the amount of water needed.

#### **Additional Criteria for Groundcovers**

On sites where grass is difficult to grow or maintain, other perennial groundcovers may be used to control erosion. Groundcovers are low-growing herbaceous plants, vines, and creeping shrubs that spread quickly to form a dense cover. These plants should not be expected to provide erosion control or prevent soil slippage on sites that are inherently unstable due to soil texture, structure, water movement, or excessive slope.

**Selection of Plant Species** - Low-maintenance groundcovers are available to suit a variety of conditions, especially for small areas around homes and commercial buildings. These plants generally require more care than turf during the initial establishment period, but may require less care after establishment.

Species recommendations may be found by consulting publications in the "References" section of this standard. Be cautious of using species that have aggressive growth habits and may spread beyond the planted area, especially if the planting is near a neighboring property or a natural area such as a shoreline or woodland. Species such as English Ivy (*Hedera helix*) and Periwinkle (*Vinca minor*) tend to grow rapidly once established, and should not be used except under well-contained conditions.

**Planting Dates** - Use Figure 1 and Table 2 to determine the appropriate planting dates for the different types of plant materials.

**Installation** - Soil shall be prepared by incorporating 2 inches of compost into the upper 8 inches of soil. If needed based on a soil test, incorporate lime and fertilizer into the soil. In the absence of a soil test for very small sites (e.g., in home landscaping areas), fertilizer may be added at the rate of 2 pounds of 5-10-10 grade fertilizer (or equivalent) per 100 square feet.

Install the plants at a spacing that is based on their present size, expected rate of growth and size at maturity, and how quickly a complete cover is desired. In general, use a spacing of one plant for every 1 to 4 square feet, and stagger the spacing of plants between rows.

Cover the entire planted slope with a mulch that will provide sufficient erosion control during the establishment period. Refer to the Mulching section of this standard for application rates and methods.

#### **Additional Criteria for Trees and Shrubs**

If trees and shrubs will be used on a critical area, the soil surface shall be stabilized with mulch or with a low-growing herbaceous planting (e.g., creeping red fescue) to control erosion until the woody plants are large enough to serve that purpose.

Refer to the Conservation Practice Standard for Conservation Cover (327) for a selected list of native tree and shrub species that may be used. Other

trees and shrubs that are native to Maryland, or are introduced and are non-invasive (i.e., not likely to spread beyond the planted area and displace native species), may also be suitable. Follow the establishment recommendations in the Maryland Job Sheet for Trees and Shrubs.

For selection and use of trees and shrubs as part of a soil bioengineering system for upland slopes, refer to Chapter 18 of the Engineering Field Handbook.

### **Additional Criteria to Stabilize Stream and Channel Banks and Shorelines**

When slopes are modified for seeding, topsoil will be stockpiled and spread over areas to be planted as needed to meet planting and landscaping needs.

**Bank and Channel Slopes.** Channel side slopes shall be shaped so that they are stable and allow establishment and maintenance of desired vegetation.

Slopes steeper than 2:1 shall not be stabilized using vegetation alone. A combination of vegetative and structural measures will be used on these slopes to ensure adequate stability.

**Species Selection.** Plant material used for this purpose shall:

- Be adapted to the hydrologic zone (see Fig. 1, page 11) into which they will be planted.
- be adapted and proven in the regions in which they will be used.
- when mature, produce plant communities that are compatible with those in the area.
- protect the channel banks but not restrict channel capacity.

**Establishment of Vegetation.** The species used, planting rates, spacing, and methods and dates of planting shall be based on plant materials program trials or other technical guidance, such as local planting guides or technical notes.

Identify, mark, and protect desirable existing vegetation during practice installation.

A combination of vegetative and structural measures using living and inert material shall be used when flow velocities, soils, and bank stability preclude stabilization by vegetative establishment alone. If the existing vegetation on a site will compete with species to be established vegetatively (e.g. bare-root, containerized, ball-and-burlap, potted), it will be controlled in a manner that ensures the successful establishment of the planted species.

**Site Protection and Access Control.** Grazing animal access to planted areas will be controlled for a minimum of two growing seasons during the establishment period.

All areas to be grazed will have a grazing plan that meets the criteria in the local Field Office Technical Guide.

Grazing shall be permanently excluded on high hazard sites, such as cut banks, areas of seepage or other potentially unstable areas.

### **Additional Criteria to Rehabilitate and Revegetate Degraded Sites that Cannot Be Stabilized through Normal Farming Practices.**

If gullies or deep rills are present, they will be filled and leveled as necessary to allow equipment operation and ensure proper site and seedbed preparation.

Based on a soil test and other appropriate site evaluations, soil amendments will be added as necessary to ameliorate or eliminate physical or chemical conditions that inhibit plant establishment and growth.

### **Additional Criteria to Restore Coastal Areas, such as Sand Dunes and Riparian Areas**

Plants for sand dunes and coastal sites must be able to survive being buried by blowing sand, sand blasting, salt spray, salt water flooding, drought, heat, and low nutrient supply.

Local plant lists including appropriate species shall be developed and utilized.

Sand trapping devices such as sand fences or brush matting shall be included in the revegetation/stabilization plans where applicable.

## CONSIDERATIONS

Species or mixes that are adapted to the site and have multiple values should be considered. Native species may be used when appropriate for the site.

To benefit pollinators and other wildlife, flowering shrubs and wildflowers with tough root systems and good soil holding capacity also should be considered for incorporation as a small percentage of a larger grass-dominated planting. Where appropriate consider a diverse mixture of legumes and forbs to support pollinator habitat.

Avoid species that may harbor pests. Species diversity should be considered to avoid loss of function due to species-specific pests. Planning and installation of other conservation practices such as Diversion (362), Obstruction Removal (500), Subsurface Drain (606), or Underground Outlet (620) may be necessary to prepare the area or ensure vegetative establishment.

Areas of vegetation established with this practice can create habitat for various type of wildlife. Maintenance activities, such as mowing or spraying, can have detrimental effects on certain species. Perform management activities at the times and in a manner that causes the least disruption to wildlife.

## PLANS AND SPECIFICATIONS

Plans and specifications for establishment and maintenance of a critical area planting shall be prepared for each site or management unit according to the Considerations, Criteria, and Operation and Maintenance described in this standard. They shall be recorded on specification sheets, job sheets, narrative statements in conservation plans, or other acceptable documentation.

When this practice is used to specify the vegetative component of another practice (e.g., grassed waterway, filter strip, pond, etc.), plans and specifications shall meet the requirements of this standard and the other applicable standard to achieve the intended purpose of the practice. The completed work shall be checked and documented to verify that the practice was completed according to the drawings and specifications of both standards. Documentation shall be in accordance with the section "Supporting Data and Documentation" in both standards.

## OPERATION AND MAINTENANCE

### General Requirements for All Plantings

Take corrective actions as needed to replace destroyed plant material or dislodged mulching material. Reshape the soil surface and replant areas where prolonged slope instability is present. Where vegetative efforts have failed, reassess the suitability of the chosen species for the site, and the need for structural measures to complement vegetative measures.

Control invasions by undesirable plants by pulling, mowing, or spraying with a selective herbicide. Where wildlife habitat is a concern, do not mow during the primary nesting season (April 15 to August 15). Control noxious weeds as required by state law.

Inspect for insects and diseases, and if an incidence threatens stand survival, take corrective action to bring the pest under control.

If fertilizer is used, it must be applied in compliance with Maryland nutrient management regulations, as applicable.

### Grasses and Legumes

During the establishment period, monitor plantings for germination success, water stress, pest problems, and damage by erosion. After one full year from planting, replant all areas with less than 85% plant cover according to the following recommendations:

1. If the stand provides less than 40% ground cover, reestablish following the original seedbed preparation, lime, fertilizer, and seeding recommendations;
2. If the stand provides 40 to 84% ground cover, overseed and fertilize using one-half the original rate. On small areas, reseeding may be accomplished by broadcasting and lightly raking the seed. For larger areas, use of a grass drill or cultipacker-seeder is preferable.

Spring seedings may require an application of fertilizer between September 1 and October 15, at least every two years, according to soil test recommendations. In lieu of a soil test, apply 30 pounds per acre (0.7 pounds per 1,000 square feet) of N, P205 and K20.

Fall seedings may require the above fertilization between March 15 and May 1 the following spring.

Mixtures dominated by legumes may only need topdressing once every three years according to soil test recommendations.

If a slow release form of nitrogen (such as Ureaform or Osmocote ) was used, a follow-up topdressing of nitrogen may not be necessary for several years.

Lime according to soil test recommendations at least once every five years. In lieu of a soil test, apply lime at the rate of 1 ton per acre (45 pounds per 1,000 square feet).

### **Groundcovers**

Use a soil test analysis to determine the need for lime and fertilizer. In lieu of a soil test, a general recommendation is to apply 2 to 3 pounds per 100 square feet of 5-10-10 fertilizer in the fall or early spring. Spread 2 to 3 inches of organic mulch such as shredded hardwood or pine bark mulch (or chips) to reduce evaporation of moisture from the soil and help reduce invasion by weeds.

Use hand tools to remove weeds from between plants. Some perennial weeds, such as thistle and dandelion, are difficult to remove by hand weeding, and may require spot treatment with a nonselective broadleaf herbicide. Care must be taken to avoid herbicide contact with the desired groundcovers or vines, because they are susceptible to being killed or severely damaged by nonselective herbicides.

Follow all label directions when using herbicides.

### **Trees and Shrubs**

Follow the maintenance recommendations in the Maryland Job Sheet for Trees and Shrubs.

## **SUPPORTING DATA AND DOCUMENTATION**

### **General Requirements for All Plantings**

The following is a list of the minimum data and documentation to be recorded in the case file:

1. Field location and extent of planting in acres, and assistance notes. Also note the location of the planting on the conservation plan map. Assistance notes shall include dates of site visits, name or initials of the person who made the visit, specifics as to alternatives discussed,

decisions made, and by whom;

2. Completed copy of the appropriate Job Sheet(s) or other specifications, and management plans. The following items shall be addressed, as appropriate:
  - a. Method of site preparation and type of seedbed preparation;
  - b. Type of problem site, or Conservation Practice Code to be seeded (if used as the planting component of another conservation practice);
  - c. Species and rates to be seeded/planted;
  - d. Seeding/planting dates;
  - e. Rate and type of soil amendments to be applied;
  - f. Rate and type of mulch and anchoring methods.

### **Additional Documentation for Construction Check Data/As-Built**

In addition to the general requirements listed above, the following is a list of minimum documentation to be included in the case file when Critical Area Planting, Code 342, is used to specify the planting component of structural practices:

1. Assistance notes shall include inspection date(s), name of the person who performed the inspection(s), specifics as to what was inspected, alternatives and adjustments discussed, decisions made and by whom;
2. Dimensions of the stabilized area;
3. Certification statement on seeding/planting;
4. Final quantities, and documentation for any quantity changes. Include materials certification when requested;
5. Sign and date check notes and plans to include the statement that the practice meets or exceeds the requirements of the NRCS conservation practice standard.



**Figure 1. Location of hydrologic zones along a channel or shoreline.**

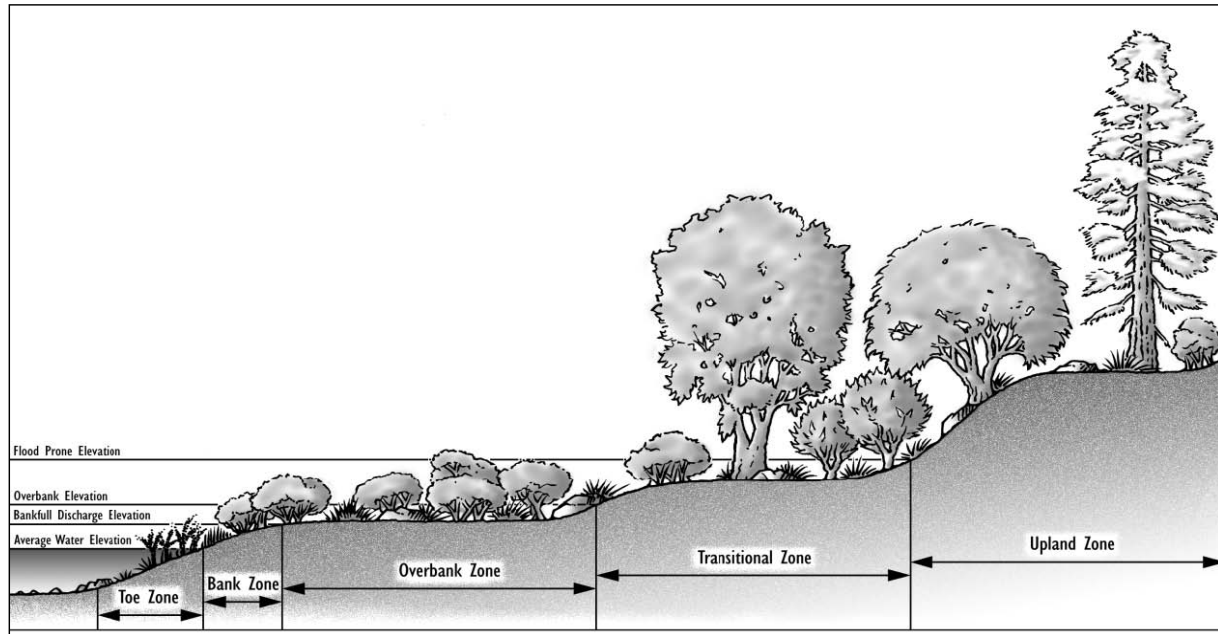

**Definitions and descriptions of hydrologic zones used for channels and shorelines:**

**Bankfull Discharge Elevation** - In natural streams, it is the elevation at which water fills the channel without overflowing onto the flood plain.

**Bank Zone** - The area above the Toe Zone located between the average water level and the bankfull discharge elevation. Vegetation may be herbaceous or woody, and is characterized by flexible stems and rhizomatous root systems.

**Overbank Zone** - The area located above the bankfull discharge elevation continuing upslope to an elevation equal to two thirds of the flood prone depth. Vegetation is generally small to medium shrub species.

**Toe Zone** - The portion of the bank that is between the average water level and the bottom of the channel, at the toe of the bank. Vegetation is generally herbaceous emergent aquatic species, tolerant of long periods of inundation.

**Transitional Zone** - The area located between the overbank zone, and the flood prone width elevation. Vegetation is usually larger shrub and tree species.

**Upland Zone** - The area above the Transitional Zone; this area is seldom if ever saturated.  
 Note: some channels or shorelines have fewer than four hydrologic zones because of differences in soils, topography, entrenchment and/or moisture regime.

## REFERENCES

Federal Interagency Stream Restoration Working Group. 1998. Stream corridor restoration: principles, processes, and practices. National *Engineering Handbook, Part 653*.

USDA-NRCS. 2007. National Engineering Handbook, Part 654. Stream restoration guide.  
USDA-NRCS. 2010.

The PLANTS Database (<http://plants.usda.gov>, checked September 2010). National Plant Data Center

Maryland Department of the Environment, Water Management Administration. *1994 Maryland Standards and Specifications for Soil Erosion and Sediment Control*.

USDA, Agricultural Marketing Service and Seed Regulatory and Testing Branch, 2000. *State Noxious-Weed Seed Requirements Recognized in the Administration of the Federal Seed Act*. Available on the internet at:  
<http://www.ams.usda.gov/AMSV1.0/getfile?dDocName=STELPRD3108724>

USDA, Natural Resources Conservation Service. *National Engineering Handbook, Part 650, Engineering Field Handbook, Chapter 18, "Soil Bioengineering for Upland Slope Protection and Erosion Reduction."*

Maryland Seeding Association, 2005. *MSA Guideline Specifications 2005 (MSA-GS-05.0)*. Available on the internet at: <http://www.marylandseeding.org/msaSpec.htm>

Penn State University, 2009. The Agronomy Guide, 2009-2010. College of Agricultural Sciences. Available on the internet at: <http://agguide.agronomy.psu.edu/>

Turner, Thomas, and Funk, David. July 2012. Recommended Turfgrass Cultivars For Certified Sod Production and Seed Mixtures in Maryland. *Technical Update TT- 77*, University of Maryland Extension  
Available on the internet at:  
<http://www.md turf council.org/admin/uploadfiles/tt77-2012.pdf>

TABLE 1: Temporary Seeding for Site Stabilization						
Plant Species	Seeding Rate <sup>1/</sup>		Seeding Depth (inches) <sup>2/</sup>	Recommended Seeding Dates by Plant Hardiness Zone <sup>3/</sup>		
	lbs./ac.	lbs./1,000 sq.ft.		5b and 6a	6b	7a, 7b and 8a
<i>Cool-Season Grasses</i>						
Annual ryegrass <i>Lolium perenne</i> ssp. <i>multiflorum</i>	40	1.0	0.5	Mar 15 to May 31 Aug 1 to Sep 30	Mar 1 to May 15 Aug 1 to Oct 15	Feb 15 to Apr 30 Aug 15 to Nov 30
Barley <i>Hordeum vulgare</i>	96	2.2	1.0	Mar 15 to May 31 Aug 1 to Sep 30	Mar 1 to May 15 Aug 1 to Oct 15	Feb 15 to Apr 30 Aug 15 to Nov 30
Oats <i>Avena sativa</i>	72	1.7	1.0	Mar 15 to May 31 Aug 1 to Sep 30	Mar 1 to May 15 Aug 1 to Oct 15	Feb 15 to Apr 30 Aug 15 to Nov 30
Wheat <i>Triticum aestivum</i>	120	2.8	1.0	Mar 15 to May 31 Aug 1 to Sep 30	Mar 1 to May 15 Aug 1 to Oct 15	Feb 15 to Apr 30 Aug 15 to Nov 30
Cereal Rye <i>Secale cereale</i>	112	2.8	1.0	Mar 15 to May 31 Aug 1 to Oct 31	Mar 1 to May 15 Aug 1 to Nov 15	Feb 15 to Apr 30 Aug 15 to Dec 15
<i>Warm-Season Grasses</i>						
Foxtail millet <i>Setaria italica</i>	30	0.7	0.5	Jun 1 to Jul 31	May 16 to Jul 31	May 1 to Aug 14
Pearl millet <i>Pennisetum glaucum</i>	20	0.5	0.5	Jun 1 to Jul 31	May 16 to Jul 31	May 1 to Aug 14

**TABLE 1 NOTES:**

- Seeding rates for the warm-season grasses are in pounds of Pure Live Seed (PLS). Actual planting rates shall be adjusted to reflect percent seed germination and purity, as tested. Adjustments are usually not needed for the cool-season grasses.  
Seeding rates listed above are for temporary seedings, when planted alone. When planted as a nurse crop with permanent seed mixes, use 1/3 of the seeding rate listed above for barley, oats, and wheat. For smaller-seeded grasses (annual ryegrass, pearl millet, foxtail millet), do not exceed more than 5% (by weight) of the overall permanent seeding mix. Cereal rye generally should not be used as a nurse crop, unless planting will occur in very late fall beyond the seeding dates for other temporary seedings. Cereal rye has allelopathic properties that inhibit the germination and growth of other plants. If it must be used as a nurse crop, seed at 1/3 of the rate listed above.  
Oats are the recommended nurse crop for warm-season grasses.
- For sandy soils, plant seeds at twice the depth listed above.
- The planting dates listed are averages for each Zone, and may require adjustment to reflect local conditions, especially near the boundaries of the zone.

NRCS - MARYLAND

JANUARY 2013

TABLE 2: Recommended Planting Dates for Permanent Cover in Maryland <sup>1f</sup>			
Type of Plant Material	Plant Hardiness Zones		
	5b and 6a	6b	7a, 7b and 8a
Seeds - Cool-Season Grasses (includes mixes with forbs and/or legumes)	Mar 15 to May 31 Aug 1 to Sep 30	Mar 1 to May 15 Aug 1 to Oct 15	Feb 15 to Apr 30 Aug 15 to Oct 31
Seeds - Warm-Season/Cool-Season Grass Mixes (includes mixes with forbs and/or legumes)	Mar 15 to May 31 ♦ Jun 1 to Jun 15*	Mar 1 to May 15 ♦ May 16 to Jun 15*	Feb 15 to Apr 30 ♦ May 1 to May 31*
Sod - Cool-Season	Mar 15 to May 31 Jun 1 to Aug 31* Sep 1 to Nov 1*†	Mar 1 to May 15 May 16 to Sep 14* Sep 15 to Nov 15*†	Feb 15 to Apr 30 May 1 to Sep 30* Oct 1 to Dec 1*†
Unrooted Woody Materials; Bare-Root Plants; Bulbs, Rhizomes, Corms, and Tubers <sup>2f</sup>	Mar 15 to May 31 Jun 1 to Jun 30*	Mar 1 to May 15 May 16 to Jun 30*	Feb 15 to Apr 30 May 1 to Jun 30*
Containerized Stock; Balled-and-Burlapped Stock	Mar 15 to May 31 Jun 1 to Jun 30* Sep 1 to Nov 15*†	Mar 1 to May 15 May 16 to Jun 30* Sep 15 to Nov 30*†	Feb 15 to Apr 30 May 1 to Jun 30* Oct 1 to Dec 15*†

**TABLE 2 NOTES:**

- The planting dates listed are averages for each zone. These dates may require adjustment to reflect local conditions, especially near the boundaries of the zones. When seeding toward the end of the listed planting dates, or when conditions are expected to be less than optimal, select an appropriate nurse crop from Table 1 and plant with the permanent seeding mix. (See Table 1, Note 1, for more information.)
- When planted during the growing season, most of these materials must be purchased and kept in a dormant condition until planting. Bare-root grasses are the exception—they may be supplied as growing (non-dormant) plants.
  - ♦ Warm-season grasses need a soil temperature of at least 50 degrees F in order to germinate. If soil temperatures are colder than 50 degrees, or moisture is not adequate, the seeds will remain dormant until conditions are favorable. In general, planting during the latter portion of this period allows more time for weed emergence and weed control prior to planting. When selecting a planting date, consider the need for weed control vs. the likelihood of having sufficient moisture for later plantings, especially on droughty sites.
  - \* Additional planting dates during which supplemental watering may be needed to ensure plant establishment.
  - † Frequent freezing and thawing of wet soils may result in frost-heaving of materials planted in late fall, if plants have not sufficiently rooted in place. Sod usually needs 4 to 6 weeks to become sufficiently rooted. Large containerized and balled-and-burlapped stock may be planted into the winter months as long as the ground is not frozen and soil moisture is adequate.

Site Condition or Purpose of the Planting	Recommended Mix (see Table 4)												
	1	2	3	4	5	6	7	8	9	10	11	12	13
Steep Slopes, Roadsides	☐	☐	☐	◆	☐	◆				◆	◆	☐	☐
Sand and Gravel Pits, Sanitary Landfills	☐	☐	☐	◆	☐	◆				◆	◆	☐	☐
Salt-Damaged Areas	◆												☐
Mine Spoil, Dredged Material, and Spoil Banks	◆		☐	◆	◆								
Utility Rights-of-Way	☐	☐	☐	☐	☐	☐	◆			☐	☐	☐	
Dikes and Dams	◆	◆	☐	◆		☐	☐	◆		☐	☐	☐	
Berms, Low Embankments ( <u>not</u> on Ponds)	☐	☐	☐	☐	☐	☐	◆	◆		☐	☐	☐	◆
Pond and Channel Banks, Streambanks	☐	☐	☐	☐	◆	◆	◆			◆	◆		
Grassed Waterways, Diversions, Terraces, Spillways	◆				◆	☐	☐	◆	☐		☐		◆
Bottom of Drainage Ditches, Swales, Detention Basins				◆		☐	◆			◆	☐		☐
Field Borders, Filter Strips, Contour Buffer Strips	☐	☐	☐	◆	◆	☐	◆	☐	☐	☐	☐	☐	◆
Wastewater Treatment Strips and Areas								☐	◆	◆			
Heavy Use Areas (Grass Loafing Paddocks for Livestock)								☐					
Athletic Fields, Residential and Commercial Lawns							◆	☐	☐		☐		
Recreation Areas								☐	☐	☐		☐	

**TABLE 3 NOTES:**

- ☐ Recommended mix for this site condition or purpose.
- ◆ Alternative mix, depending on site conditions.

**TABLE 4: Selected List of Permanent Herbaceous Seeding Mixtures**

Mix	Recommended Cultivar	Seeding Rate <sup>1</sup>		Soil Drainage Class <sup>2</sup>	Max. Height (feet)	Maint. Level <sup>3</sup>	Remarks
		lbs./ac.	lbs./1000 sq. ft.				
<b>WARM-SEASON/COOL-SEASON GRASS MIXES</b>							
<b>1. SELECT ONE WARM-SEASON GRASS:</b>							
Switchgrass <i>Panicum virgatum</i> <b>OR</b>	Blackwell, Carthage, Cave-in-Rock, or Shelter	10	0.23				All species are native to Maryland. Plant this mix with a regular grass drill.
Coastal panicgrass <i>Panicum amarulum</i> var. <i>amarulum</i>	Atlantic	10	0.23				
<b>AND ADD:</b>							
Creeping red fescue <i>Festuca rubra</i> var. <i>rubra</i>	Dawson, Pennlawn, Flyer, Fortess, Ruby, or Salem	15	0.34	E - P	4 - 7	C - D	Coastal panicgrass is best adapted to Zones 7a and 7b. Creeping red fescue is a cool-season grass that will provide erosion protection while the warm-season grass (switchgrass or coastal panicgrass) is becoming established.
<b>PLUS ONE OF THE FOLLOWING LEGUMES:</b>							
Partridge pea <i>Chamaecrista fasciculata</i>	Common	4	0.09				Switchgrass, coastal panicgrass, the 'Dawson' variety of creeping red fescue, and partridge pea are moderately salt-tolerant. Do not use bush clover or wild indigo on wet sites.
Bush clover <i>Lespedeza capitata</i>	Common	2	0.05				
Wild indigo <i>Baptisia tinctoria</i>	Common	2	0.05				
<b>2. Big bluestem <i>Andropogon gerardii</i></b>							
Indiangrass <i>Sorghastrum nutans</i>	Niagara or Roundtree	6	0.14				All species are native to Maryland. The Indiangrass and bluestems have fluffy seeds. Plant with a specialized native seed drill.
Little bluestem <i>Schizachyrium scoparium</i>	Rumsey	6	0.14				
Creeping red fescue <i>Festuca rubra</i> var. <i>rubra</i>	Aldous or Blaze	4	0.09				Creeping red fescue is a cool-season grass that will provide erosion protection while the warm-season grasses are becoming established.
Partridge pea <i>Chamaecrista fasciculata</i>	Dawson, Pennlawn, Flyer, Fortess, Ruby, or Salem	15	0.34	E - MW	6 - 8	C - D	
<b>PLUS ONE OF THE FOLLOWING LEGUMES:</b>							
Partridge pea <i>Chamaecrista fasciculata</i>	Common	4	0.09				All species are native to Maryland. The Indiangrass and bluestems have fluffy seeds. Plant with a specialized native seed drill.
Bush clover <i>Lespedeza capitata</i>	Common	2	0.05				

**TABLE 4: Selected List of Permanent Herbaceous Seeding Mixtures**

Mix	Recommended Cultivar	Seeding Rate <sup>1</sup>		Soil Drainage Class <sup>2</sup>	Max. Height (feet)	Maint. Level <sup>3</sup>	Remarks
		lbs./ac.	lbs./1000 sq .ft.				
<b>WARM-SEASON/COOL-SEASON GRASS MIXES</b>							
Wild indigo <i>Baptisia tinctoria</i>	Common	2	0.05				
Showy tick-trefoil <i>Desmodium canadense</i>	Common	1	0.02				
<b>3. SELECT THREE GRASSES:</b>							
Deertongue <i>Dichanthelium clandestinum</i>	Tioga	20	0.46				Excellent for excessively droughty, low pH (acidic) soils.
Sheep fescue <i>Festuca ovina</i> <b>OR</b>	Common or Bighorn	20	0.46				Sheep fescue, Canada wild rye, and redbtop are cool-season grasses that will provide erosion protection while the warm-season grass (deertongue) is becoming established.
Canada wild rye <i>Elymus canadensis</i>	Common	3	0.07				
Redtop <i>Agrostis gigantea</i>	Streaker	1	0.02	E - MW	4 - 6	C - D	
<b>PLUS ONE OF THE FOLLOWING LEGUMES:</b>							
Common lespedeza <i>Lespedeza striata</i>	Kobe	10	0.23				Common lespedeza ('Kobe' variety) is more tolerant of low acidity and high manganese concentrations than Korean lespedeza. These lespedezas are reseeding annuals.
Korean lespedeza <i>Lespedeza stipulacea</i>	Climax or Rowan	10	0.23				
<b>4. Deertongue <i>Dichanthelium clandestinum</i></b>	Tioga	15	0.34				
Creeping red fescue <i>Festuca rubra</i> var. <i>rubra</i>	Dawson, Pennlawn, Flyer, Fortess, Ruby, or Salem	20	0.46	W - P	2 - 3	C - D	Use Virginia wild rye on moist, shady sites.
Virginia wild rye <i>Elymus virginicus</i> <b>OR</b>	Common	5	0.11				Use Canada wild rye on droughty sites.
Canada wild rye <i>Elymus canadensis</i>	Common	5	0.11				

**TABLE 4: Selected List of Permanent Herbaceous Seeding Mixtures**

Mix	Recommended Cultivar	Seeding Rate <sup>1/</sup>		Soil Drainage Class <sup>2/</sup>	Max. Height (feet)	Maint. Level <sup>3/</sup>	Remarks
		lbs./ac.	lbs./1000 sq.ft.				
<b>COOL-SEASON GRASS MIXES</b>							
<b>5. SELECT TWO GRASSES:</b>							
Creeping red fescue <i>Festuca rubra</i> <u>OR</u> var. <i>rubra</i> Hard fescue <i>Festuca trachyphylla</i> Perennial ryegrass <i>Lolium perenne</i> <u>OR</u> Redtop <i>Agrostis gigantea</i>  <b>AND ADD THE FOLLOWING LEGUME:</b> Flatpea <i>Lathyrus sylvestris</i>	Dawson, Pennlawn, Flyer, Fortess, Ruby, or Salem	20	0.46				Use creeping red fescue in heavy shade and on moist sites. Perennial ryegrass and redtop will establish more rapidly than either fescue. Redtop tolerates wet sites better than ryegrass. Flatpea will suppress woody vegetation. It should be planted in the spring, or as a dormant seeding in late fall or winter. It must be incorporated into the soil or covered with mulch. It may not be winter-hardy if planted late summer - fall. <b>Caution:</b> Flatpea can spread aggressively, and can be toxic to livestock.
	Atila or Aurora	20	0.46				
	Blazer (I), Pennfine	10	0.23				
	Streaker	1	0.02	E - SP	2 - 3	B - D	
	Lathco	15	0.34				
<b>6. Tall fescue <i>Schedonorus arundinaceus</i></b>							
Perennial ryegrass <i>Lolium perenne</i> <b>PLUS ONE OF THE FOLLOWING LEGUMES:</b> Birdsfoot trefoil <i>Lotus corniculatus</i> White clover <i>Trifolium repens</i>	Recommended MD turf-types <sup>4/</sup>	40	0.93				Birdsfoot trefoil is suitable for use only in Zones 5b and 6a.
	Blazer (I), Pennfine	25	0.57				
	Empire, Viking, Norcen, Leo Common	8 5	0.18 0.11	W - SP	2 - 3	C - D	
<b>7. Creeping red fescue <i>Festuca rubra</i> var. <i>rubra</i></b>							
Kentucky bluegrass <i>Poa pratensis</i>	Dawson, Pennlawn, Flyer, Fortess, Ruby, or Salem	60	1.38				This mix has good shade tolerance.
	Recommended MD turf-types <sup>4/</sup>	15	0.34	W - MW	1 - 2	C - D	



TABLE 4: Selected List of Permanent Herbaceous Seeding Mixtures

Mix	Recommended Cultivar	Seeding Rate <sup>1)</sup>		Soil Drainage Class <sup>2)</sup>	Max. Height (feet)	Maint. Level <sup>3)</sup>	Remarks
		lbs./ac.	lbs./1000 sq.ft.				
<b>COOL-SEASON GRASS MIXES</b>							
8. Tall fescue <i>Schedonorus arundinaceus</i>	Recommended MD turf-types <sup>4)</sup>	100	2.3	E - SP	2 - 3	A - D	Tall fescue produces a dense turf if frequently mowed, but tends to be clumpy if mowed only occasionally. For best results, recommend using a blend of 3 cultivars.  Use low-endophyte cultivars in areas where livestock may graze.  Good for highly managed athletic fields.
<b>9. SELECT ONE SPECIES OF FESCUE:</b>							
Tall fescue <i>Schedonorus arundinaceus</i> OR	Recommended MD turf-types <sup>4)</sup>	60	1.38				
Hard fescue <i>Festuca trachyphylla</i>	Attila or Aurora	40	0.92				Tall fescue is more suitable for compacted, high use areas and on moist sites.
AND ADD:							
Kentucky bluegrass <i>Poa pratensis</i>	Recommended MD turf-types <sup>4)</sup>	40	0.92	W - SP	2 - 3	A - B	Hard fescue produces finer-textured turf with more shade tolerance.
Perennial ryegrass <i>Lolium perenne</i>	Blazer (I), Pennfine	20	0.46				Use tall fescue instead of hard fescue for wastewater treatment strips and areas.
<b>10. Orchardgrass</b>							
<i>Dactylis glomerata</i>	Any	25	0.57				For best results, recommend using a blend of 3 cultivars each for tall fescue and Kentucky bluegrass.
Creeping red fescue <i>Festuca rubra</i> var. <i>rubra</i>	Dawson, Pennlawn, Flyer, Fortess, Ruby, or Salem	10	0.23	W - SP	2 - 3	C - D	Low maintenance mix that is easy to establish.
Redtop <i>Agrostis gigantea</i>	Streaker	1	0.02				
Alsike clover <i>Trifolium hybridum</i>	Common	3	0.07				Alsike clover can be toxic to horses.

**TABLE 4: Selected List of Permanent Herbaceous Seeding Mixtures**

Mix	Recommended Cultivar	Seeding Rate <sup>1</sup>		Soil Drainage Class <sup>2</sup>	Max. Height (feet)	Maint. Level <sup>3</sup>	Remarks
		lbs./ac.	lbs./1000 sq.ft.				
<b>COOL-SEASON GRASS MIXES</b>							
White clover <i>Trifolium repens</i>	Common	3	0.07				Omit the clovers if using this mix for wastewater treatment strips and areas.
11. Creeping red fescue <i>Festuca rubra</i> var. <i>rubra</i>	Dawson, Pennlawn, Flyer, Fortress, Ruby, or Salem	30	0.69				
Chewings fescue <i>Festuca rubra</i> ssp. <i>commutata</i>	Common	30	0.69				
Kentucky bluegrass <i>Poa pratensis</i>	Recommended MD turf-types <sup>4</sup>	20	0.46	E - MW	2 - 3	B - D	
<b>OPTIONAL ADDITION</b> Rough bluegrass <i>Poa trivialis</i>	Common	15	0.34				Add rough bluegrass in moist, shady conditions.
12. Creeping red fescue <i>Festuca rubra</i> var. <i>rubra</i>	Dawson, Pennlawn, Flyer, Fortress, Ruby, or Salem	25	0.57				Attractive mix of fine fescues and wildflowers for low maintenance conditions. Once well-established, the grasses may tend to outcompete the wildflowers.
Hard fescue <i>Festuca trachyphylla</i>	Attalia or Aurora	25	0.57	E - MW	2 - 3	C - D	Wildflowers are best established by broadcasting and outpacking on a
Sheep fescue <i>Festuca ovina</i>	Common or Bighorn	25	0.57				

**TABLE 4: Selected List of Permanent Herbaceous Seeding Mixtures**

Mix	Recommended Cultivar	Seeding Rate <sup>1</sup>		Soil Drainage Class <sup>2</sup>	Max. Height (feet)	Maint. Level <sup>3</sup>	Remarks
		lbs./ac.	lbs./1000 sq.ft.				
<b>COOL-SEASON GRASS MIXES</b>							
<b>PLUS WILDFLOWER MIX:</b>							
Black-eyed susan	<i>Rudbeckia hirta</i>	2	0.05				prepared seedbed. Drilling can be also used, but care must be taken so that seeds are not drilled too deep.  Hydroseeding is not recommended for this mix if wildflowers are used. (They have very small seeds.)
Lance-leaved coreopsis	<i>Coreopsis lanceolata</i>	2	0.05				
Wild bergamot	<i>Monarda fistulosa</i>	2	0.05				
Partridge pea	<i>Chamaecrista fasciculata</i>	5	0.11				
<b>OR ADD CLOVER MIX:</b>							
White clover	<i>Trifolium repens</i>	3	0.07				
Red clover	<i>Trifolium pratense</i>	3	0.07				
<b>13. Alkali Saltgrass: <i>Puccinellia distans</i></b>							
Creeping Red Fescue	<i>Festuca rubra</i> var. <i>rubra</i>	20	0.46				This is the recommended mix for saline sites. Saltgrass will persist only under saline conditions.  For best results, use only the Dawson variety of creeping red fescue. It is a salt-tolerant variety.
Fowl Meadowgrass	<i>Poa palustris</i>	15	0.34				
<b>OPTIONAL ADDITION</b>							
Creeping Bentgrass	<i>Agrostis stolonifera</i>	2	0.05	W - P	2 - 3	B - D	Add bentgrass for wetter conditions.

**TABLE 4 NOTES:**

- Seeding Rates:** Seeding rates for the warm-season grasses are in pounds of Pure Live Seed (PLS). Actual planting rates shall be adjusted to reflect percent seed germination and purity, as tested. Adjustments are usually not needed for the cool-season grasses, legumes, or wildflowers. All legume seeds shall be inoculated before planting with the appropriate *Rhizobium* bacteria. When feasible, hard-seeded legumes should be scarified to improve germination.
- Soil Drainage Class** (refer to the county soil survey for further information):  
E - Excessively Drained; W - Well Drained; MW - Moderately Well Drained; SP - Somewhat Poorly Drained; P - Poorly Drained.
- Maintenance Level:**
  - Intensive mowing (every 2 - 4 days), fertilization, lime, insect and weed control, and watering (examples: high maintenance lawns and athletic fields).
  - Frequent mowing (every 4 - 7 days), occasional fertilization, lime, pest control, and watering (examples: residential, school, and commercial lawns).
  - Periodic mowing (every 7 - 14 days), occasional fertilization and lime (examples: residential lawns, parks).
  - Infrequent or no mowing, fertilization, or lime after the first year of establishment (examples: wildlife areas, roadsides, steep banks)
- Turf-type cultivars of Tall Fescue and Kentucky Bluegrass shall be selected based on recommendations of the University of Maryland Extension, Turfgrass Technical Update TT-77. (See the "References" section of this standard.)

*To avoid livestock health problems due to endophyte toxicity, use varieties that are endophyte-free or are novel endophyte-infected for critical area plantings where livestock may be allowed to graze (e.g., heavy use grass loafing paddocks). Fescue with the novel endophyte is not toxic to livestock, and has the adaptive advantages of being more resistant to drought, disease, and insects than endophyte-free varieties. Please note that endophyte levels in plantings can vary between varieties, between fields of the same variety, and with the time of year. For areas where livestock will not have access, cultivars with higher endophyte levels are desirable because they tend to be more drought tolerant and more resistant to disease and insect damage. Certified varieties of endophyte-infected tall fescue (such as Kentucky-31) may be used for stockpile grazing (i.e., winter grazing) when the risk of endophyte toxicity is much reduced.*

**TABLE 5: Quality of Seed**

Species	Minimum Seed Purity (%)	Minimum Seed Germination (%)	Species	Minimum Seed Purity (%)	Minimum Seed Germination (%)
<i>COOL-SEASON GRASSES</i>			<i>WARM-SEASON GRASSES</i>		
Barley	98	85	Bluestem, Big	60	60
Bentgrass, Creeping	95	85	Bluestem, Little	55	60
Bluegrass, Canada	90	80	Deertongue	95	75
Bluegrass, Kentucky	97	80	Indiangrass	60	60
Bluegrass, Rough	96	80	Millet, Foxtail or Pearl	98	80
Fescue, Chewings	97	85	Panicgrass, Coastal	95	70
Fescue, Creeping Red	97	85	Switchgrass	95	75
Fescue, Hard	97	85	<i>LEGUMES/FORBS</i>		
Fescue, Sheep	97	85	Clover, Alsike	99	85
Fescue, Tall	97	85	Clover, Bush	--	--
Meadowgrass, Fowl	--	--	Clover, Red	99	85
Oats	98	85	Clover, White	98	90
Orchardgrass	90	80	Flatpea	98	75
Redtop	92	80	Indigo, Wild	--	--
Rye, Cereal	98	85	Lespedeza, Common	98	80
Ryegrass, Annual or Perennial	97	85	Lespedeza, Korean	98	80
Saltgrass, Alkali	85	80	Pea, Partridge	98	70
Wheat	98	85	Tick-Trefoil, Showy	--	--
Wild Rye, Canada	85	70	Trefoil, Birdsfoot	98	85
Wild Rye, Virginia	--	--	Wildflowers	--	--

**TABLE 5 NOTE:**

- All seed shall comply with the Maryland State Seed Law. Seed shall be free of prohibited or restricted noxious weeds, as currently listed by the Maryland Department of Agriculture, Turf and Seed Section

## APPENDIX D.1

### SOIL CONSERVATION DISTRICT CONTACTS

For The Most Up-To-Date Information about Local Soil Conservation Districts, view the Maryland Association of Soil Conservation Districts web site at [MASC.D.NET](http://MASC.D.NET), or the Natural Resource Conservation Service Web Site at [NRCS.USDA.GOV](http://NRCS.USDA.GOV).

#### **Allegheny**

12407 Naves Cross Road, NE Cumberland,  
MD 21502  
(301) 777-1494

#### **Anne Arundel**

2662 Riva Road, Suite 150  
Annapolis, MD 21401 (410)  
571-6757

#### **Baltimore County**

1114 Shawan Road, Suite 4  
Cockeysville, MD 21030 (410)  
527-5920

#### **Calvert**

65 Duke Street, Room 106  
PO Box 657  
Prince Frederick, MD 20678 (410)  
535-1521

#### **Caroline**

640 Legion Road, Suite 3  
Denton, MD 21629 (410)  
479-1202 ext. 3

#### **Carroll**

698J Corporate Center Court  
Westminster, MD 21157 (410)  
848-8200 ext. 3

#### **Cecil**

101 Chesapeake Blvd, Suite B-3  
Elkton, MD 21921  
(410) 398-4411

#### **Charles**

101 Catalpa Drive, Suite 106C  
P.O. Box 269  
La Plata, MD 20646  
(301) 934-9588

#### **Dorchester**

204 Cedar Street, Suite 201  
Cambridge, MD 21613  
(410) 228-5640

#### **Frederick**

92 Thomas Johnson Drive, Suite 230  
Frederick, MD 21702  
(301) 695-2803

#### **Garrett**

1916 Maryland Hwy, Suite C  
Mountain Lake Park, MD 21550  
(301) 334-6950

#### **Harford**

19 New Port Drive, Suite 103  
Forest Hill, MD 21050  
(410) 838-6181

#### **Howard**

708 Lisbon Center Drive, Suite E  
Woodbine, MD 21797  
(410) 489-7987

#### **Kent**

122 Speer Rd, Suite 4  
Chestertown, MD 21620  
(410) 778-5353

**Montgomery**

18410 Muncaster Road  
Derwood, MD 20855  
(301) 590-2855

Additional erosion and sediment control information  
can be obtained from:

Montgomery County Department of Permitting  
Services  
250 Hungerford Drive  
Rockville, MD 20850  
(240) 777-6343

**Prince George's**

5301 Marlboro Race Track Road  
Upper Marlboro, MD 20772  
(301) 574-5162

**Queen Anne's**

211 East Water Street  
Centreville, MD 21617  
(410) 758-3136 ext. 3

**St. Mary's**

P.O. Box 810  
26737 Radio Station Way  
Leonardtown, MD 20650  
(301) 475-8402

**Somerset**

30730 Park Drive  
Princess Anne, MD 21853  
(401) 651-0370

**Talbot**

215 Bay Street  
Easton, MD 21601  
(410) 822-1577

**Washington**

1260 Maryland Ave., Suite 101  
Hagerstown, MD 21740  
(301) 797-6820

**Wicomico**

2322-B Goddard Pkwy.  
Salisbury, MD 21801  
(410) 546-4777

**Worcester**

304 Commerce St.  
Snow Hill, MD 21863  
(410) 632-5439

## APPENDIX D.2

### MARYLAND DEPARTMENT OF THE ENVIRONMENT CONTACTS FOR FOREST HARVEST OPERATIONS

MARYLAND DEPARTMENT OF THE ENVIRONMENT Water Management Administration  
1800 Washington Blvd. Baltimore, Maryland 21230

#### LIST OF MDE CONTACTS FOR FOREST HARVEST OPERATIONS

##### COMPLIANCE PROGRAM (410) 537-3510

This program can answer questions relating to approved erosion and sediment control plans, tidal and nontidal wetlands, and waterway authorizations. There are three divisions, each covering a specific region of the state. Contact the division covering the county where the activity is occurring.

##### INSPECTION DIVISIONS

WESTERN DIVISION (301) 689-1480 – Frostburg  
(301) 665 2850 – Hagerstown  
Allegany, Carroll, Frederick, Garrett, Howard, Montgomery, Prince George's and Washington Counties

CENTRAL DIVISION (410) 537-3510 – Baltimore  
(443) 482-2700 – Annapolis  
Baltimore City, Anne Arundel, Baltimore, Calvert, Charles, and Saint Mary's Counties

EASTERN DIVISION (410) 901-4020 – Cambridge  
Caroline, Cecil, Dorchester, Harford, Kent, Queen Anne's, Somerset, Talbot Wicomico, and Worcester Counties

SEDIMENT, STORMWATER AND DAM SAFETY PROGRAM (410) 537-3543  
this program reviews and approves erosion and sediment control and stormwater management on State or federal construction projects. It can also supply information to the private sector. This program is also responsible for implementation of the Statewide sediment control program including the Responsible Personnel Certification Training.

WETLANDS AND WATERWAYS PROGRAM (410) 537-3745 – State Office  
(301) 689-1490 - Frostburg  
(410) 537-3789 - Baltimore  
(410) 713-3685 – Salisbury

This program issues the tidal and nontidal wetland authorizations and waterway permits commonly needed for forest harvest projects.

**APPENDIX D.3**  
**DEPARTMENT OF NATURAL RESOURCES**  
**MARYLAND FOREST SERVICE**

**MARYLAND DEPARTMENT OF NATURAL RESOURCES FOREST SERVICE**

580 Taylor Avenue  
Tawes State Office Building  
Annapolis, Maryland 21401  
(410) 260-8367  
1-877-620-8367 (Toll-free in Maryland)

---

**CENTRAL REGIONAL OFFICE**

2 South Bond Street, Suite 101  
Bel Air, MD 21014  
(410) 836-4550  
(410) 836-4562 Fax

**Baltimore County**

Cub Hill Ranger Station  
9405 Old Harford Road  
Baltimore, MD 21234  
(410) 665-5820

**Cecil County**

Black Hill Ranger Station  
130 McKinneytown Road  
North East, MD 21901  
(410) 287-5777

**Carroll County**

328-A East Nicodemus Road  
Westminster, MD 21157  
(410) 848-9290

**Harford County**

2 S. Bond Street  
Suite 101  
Bel Air, MD 21014  
(410) 836-4579

**Howard\Montgomery Counties**

17400 Annapolis Rock Road  
Woodbine, MD 21797  
Montgomery: (301) 854-6060  
Howard: (410) 442-2080



**EASTERN REGIONAL OFFICE**

201 Baptist Street, Suite 22

Salisbury, MD 21801

(410) 713-3840

(410) 713-3849 Fax

**Caroline/Talbot Counties**

Martinak State Park  
105 Deep Shore Road  
Denton, MD 21629  
(410) 479-1623

**Dorchester County**

4329 Golden Hill Road  
Church Creek, MD 21622  
(410) 228-1861

**Kent/Queen Anne's Counties**

120 Broadway Avenue  
Centreville, MD 21617  
Kent: (410) 778-4439  
Queen Anne: (410) 819-4120

**Wicomico County**

Powellville Work Center  
6095 Sixty Foot Road  
Parsonsburg, MD 21849  
(410) 543-1950

**Somerset/Worcester County**

10990 Market Lane  
Princess Anne, MD 21853  
Somerset: (410) 651-2004  
Worcester: (443) 235-1636

**SOUTHERN REGIONAL OFFICE**

6904 Hallowing lane  
Prince Frederick, MD 20678  
(410) 535-3382  
(410) 535-4737 Fax

**Anne Arundel / Prince Georges County**

Forestry Education Center  
8023 Long Hill Road  
Pasadena, MD 21122  
(410) 360-8421

**Calvert County**

6904 Hallowing Lane  
Prince Frederick, MD 20678  
(410) 535-1303

**Charles County**

Bhaduri Building  
Maple Avenue  
P.O. Box 2746  
La Plata, MD 20646  
(301) 934-2543

**St. Mary's County**

Carter Building  
23110 Leonard Hall Drive  
Leonardtwn MD 20650  
(301) 880-2747

---

**WESTERN REGIONAL OFFICE**

12500 Pleasant Valley Road  
Flintstone, MD 21530  
(301) 777-2134  
(301) 777-5865 Fax

**Allegheny County**

3 Pershing Street, Room #101  
Cumberland, MD 21502  
(301) 777-2027

**Garret County**

1728 Kings Run Road  
Oakland, MD 21550  
(301) 334-3296

**Frederick County**

8602 Gambrell Road  
Frederick, MD 21702  
(301) 473-8417

**Washington County**

14038 Blairs Valley Road  
Clear Spring, MD 21722  
(301) 791-4733

## **APPENDIX E**

### **FOREST CONSERVATION ACT (FCA)**

Early in 1990, Maryland's Governor Schaeffer created a Task Force to assess the problems and potential of Maryland's trees and forests to promote land stewardship. One recommendation of the Task Force was creation of a forest conservation, protection and reforestation law.

The main purpose of the Maryland Forest Conservation Act (Natural Resources Article, Section 5-1601 through 5-1613) enacted in 1991 was to minimize the loss of Maryland's forest resources during land development by making the identification and protection of forests and other sensitive areas an integral part of the site planning process. Identification of priority areas prior to development makes sensitive area retention possible. Of primary interest are areas adjacent to streams or wetlands, those on steep or erodible soils or those within or adjacent to large contiguous blocks of forest or wildlife corridors.

Although the Maryland Department of Natural Resources-Forest Service (DN-FS) administers the FCA, it is implemented on a local level. Gaining approval of the required Forest Conservation Plan (for a development of more than 1 acre) may require long term protection of included priority areas or planting / replanting (afforestation or reforestation) a sensitive area off-site.

Any activity requiring an application for a subdivision, grading permit or sediment control permit on areas 40,000 square feet (approximately 1 acre) or greater is subject to the Forest Conservation Act and will require a forest conservation plan prepared by a Licensed Professional Forester, licensed landscape architect, or other qualified professional.

#### **Contact Person:**

**Marian Honeczy**

Supervisor of Urban Programs & FCA Coordinator  
Maryland Department of Natural Resources – Forest Service  
Tawes State Office Building E-1  
580 Taylor Avenue  
Annapolis, MD 21401-2397  
(410) 260-8511  
[marian.honeczy@maryland.gov](mailto:marian.honeczy@maryland.gov)

**APPENDIX F**  
**CHESAPEAKE AND ATLANTIC COASTAL BAYS CRITICAL AREA**  
**Appendix F.1**  
**COMMISSION CONTACTS**

The Critical Area Commission For the Chesapeake and Atlantic Coastal Bays has established regulations for the protection of the area within 1000 feet of the mean high waterline. Seventeen counties and over 35 towns have used these criteria to develop and implement their own Critical Area programs. The state office is located at:

**Chesapeake Bay Critical Area Commission**

1804 West Street  
 Annapolis, MD 21401  
 (410) 260-3460  
 (410) 974-5338 Fax

**CRITICAL AREA COMMISSION LOCAL OFFICES**

<b>Anne Arundel County</b>	<b>410-222-7960</b>	<b>Kent County</b>	<b>410-778-7475</b>
Annapolis	410-263-7961	Betterton	410-348-5522
Highland Beach	410-268-2956	Chestertown	410-778-0500
<b>Baltimore City</b>	<b>410-396-8361</b>	Millington	410-928-3880
<b>Baltimore County</b>	<b>410-887-3980</b>	Rock Hall	410-639-7611
<b>Calvert County</b>	<b>410-535-1600 x 2338</b>	<b>Prince George's County</b>	<b>301-883-5900</b>
Chesapeake Beach	301-855-8398	Eagle Harbor	301-888-2410
North Beach	301-855-6681	<b>Queen Anne's County</b>	<b>410-758-1255</b>
<b>Caroline County</b>	<b>410-479-8100</b>	Centreville	410-758-1180
Denton	410-479-2050	Church Hill	410-758-3740
Federalburg	410-754-8173	Queen Anne	410-364-9229
Greensboro	410-482-6222	Queenstown	410-827-7646
Hillsboro	410-820-1247	<b>St. Mary's County</b>	<b>301-475-4200</b>
<b>Cecil County</b>	<b>410-996-5220</b>	Leonardtown	301-475-9791
Charlestown	410-287-6173	<b>Somerset County</b>	<b>410-651-1424</b>
Chesapeake City	410-885-5298	Crisfield	410-968-1333
Elkton	410-398-4999	Princess Anne	410-651-1818
North East	410-287-5801	<b>Talbot County</b>	<b>410-770-8030</b>
Perryville	410-642-6066	Easton	410-822-1943
Port Deposit	410-378-2121	Oxford	410-226-5122
<b>Charles County</b>	<b>301-645-0540</b>	St. Michael's	410-745-9535
Indian Head	301-743-5511	<b>Wicomico County</b>	<b>410-548-4860</b>
<b>Dorchester County</b>	<b>410-228-3234</b>	Fruitland	410-548-2800
Brookview	410-943-4977	Mardela Springs	410-742-8011
Cambridge	410-228-4020	Salisbury	410-548-3140
Church Creek	410-228-7030	Sharptown	410-883-3767
El Dorado	410-943-4187	<b>Worcester County</b>	<b>410-632-1200</b>
Galestown	410-883-3156	Ocean City	410-289-8825
Vienna	410-376-3442	Pocomoke City	410-957-1633
<b>Harford County</b>	<b>410-638-3103</b>	Snow Hill	410-632-2080
Havre de Grace	410-939-1800 x1131		
Aberdeen	410-272-1600		

## **APPENDIX F.2**

### **CHESAPEAKE AND ATLANTIC COASTAL BAYS CRITICAL AREAS INFORMATION**

The Chesapeake Bay Critical Area is the land within 1,000 feet of the Chesapeake Bay and its tidal waters or tidal wetlands. Timber harvests in the Chesapeake Bay Critical Area which are regulated by the Critical Area Criteria are 1 acre or more in size and occur within a 1 year interval.

#### **Critical Area Requirements**

A *Timber Harvest Plan* must be prepared and approved before any timber can be harvested on 1 acre or more of forest in the Critical Area that will be cut within any 1 year interval,. The approval process is a partnership between a District Forestry Board and the Department of Natural Resources (DNR). A Custom Erosion and Sediment Control Plan for Forest Harvest Operations is required for harvests that disturb 5,000 square feet or more in the Critical Area.

The Critical Area regulations affect timber harvests in two categories: (1) Forest and Woodland Protection and (2) Habitat Protection Areas.

#### **Forest and Woodland Protection**

The following information must be included in a Timber Harvest Plan to meet the forest and woodland protection regulations:

1. Description of measures to maintain surface water and groundwater quality,
2. A determination of whether the harvest will disturb or affect Habitat Protection Areas, and description of measures incorporated to protect any Habitat Protection Area,
3. A description of the timing, intensity, and size of the harvest so as to assure continuity of wildlife habitat,;
4. Confirmation of an Custom Erosion And Sediment Control Plan for Forest Harvest Operations,
5. Confirmation that cutting in the buffer, as defined below, will be in accordance with the buffer regulations.

#### **Habitat Protection Areas**

*Habitat Protection Areas* fall into five categories:

1. Buffers,
2. Nontidal wetlands (NTW),
3. Habitat for threatened or endangered species,
4. Other plant and wildlife habitat,
5. Anadromous fish spawning areas.

Unless no feasible alternative exists, roads, bridges, or utilities may not be located in any portion of a Habitat Protection Area. Where any road, bridge or utility must cross a buffer coincident with another type of Habitat Protection Area, a variance must be obtained through the process described below in this appendix, under the heading "Variances".

### **Buffer**

Within the 1,000 foot wide Critical Area, a minimum 100-foot buffer must be maintained around all waterways or tidal wetlands. Cutting is allowed in the landward (outermost) 50 feet of the buffer under two circumstances:

1. The area can be selectively cut; OR
2. The area can be clear-cut if the stand is predominantly (50 percent or more) loblolly pine or yellow poplar.

The buffer is to be maintained in natural vegetation, but may include planted vegetation where necessary to protect, stabilize, or enhance the shoreline. Roads and skid trails may not be constructed in the buffer, even if the outer, landward 50 feet is being cut.

Under certain circumstances, buffers can also be expanded and tree cutting prohibited. The buffer is expanded where sensitive areas such as steep slopes (over 15 percent), undrained hydric soils, or highly erodible soils are adjacent to the 100 foot buffer. For slopes over 15 percent, the buffer is expanded by 4 feet for each 1 percent of slope, or to the top of the slope, whichever is greater in extent. For highly erodible soils, the buffer is expanded to the edge of the erodible soil map unit or to where the slope is less than 5 percent. The buffer can be expanded to include nontidal wetlands.

### **Nontidal Wetlands (NTW)**

Cutting timber is allowed in NTW and hydric soils, although care must be taken in harvesting wet areas to avoid irreparable damage.

The following criteria must be met in Timber Harvest Plans:

1. At least a 25-foot buffer is to be maintained around NTW.
2. Minimize disturbances to the surface and subsurface flow of water of NTW.
3. A wetlands mitigation plan must be prepared and carried out.

The harvest or associated activity such as road building must be of substantial economic benefit and the impacts to the wetlands must be unavoidable and necessary. The mitigation plan must outline measures to provide water quality benefits and plant and wildlife habitat equivalent to the wetlands destroyed or altered. Replacement should be accomplished on-site or near the affected wetland where possible and in the same watershed.

The wetlands mitigation plan must be part of the Timber Harvest Plan submittal to the District Forestry Board. BMPs will be implemented through the Custom Erosion and Sediment Control Plan for Forest Harvest Operations and the plan or a draft plan must be presented to the District Forestry Board before a Timber Harvest Plan for NTW may be approved.

## **Habitat for Threatened and Endangered Species in Need of Conservation**

Timber Harvest Plans must identify habitats of any species designated by the Secretary of the DNR or by the Federal Endangered Species Act as species in need of conservation, threatened, or endangered. The following criteria are to be used to judge the adequacy of protection measures included in the Timber Harvest Plan:

1. A protection area is designated around each of the habitats within which disturbance is prohibited unless it is shown in the Timber Harvest Plan that the harvest activities will not have or cause adverse impacts to the species or its habitat. The recommendation from the DNR - Wildlife and Heritage Program should be included.
2. Special provisions for protection are included in the forest management recommendations for the harvest.
3. The landowner(s) enter(s) conservation easements or other cooperative agreements that provide protection (optional).

## **Other Plant and Wildlife Habitat**

Other plant and wildlife habitats include forest interior dwelling bird habitat, riparian forests, forests of 100 acres or more, colonial nesting waterbird areas, plant and wildlife habitat of local significance, and Natural Heritage Areas.

All Timber Harvest Plans must identify the types of plant and wildlife habitat listed below:

1. Colonial waterbird nesting sites,
2. Historic waterfowl staging and concentration areas in tidal waters, tributary streams, or NTW,
3. Existing riparian forests,
4. Forest areas utilized for breeding by forest interior dwelling birds and other wildlife,
5. Other plant and wildlife habitats determined by the local Critical Area Program to be of local significance,
6. Natural Heritage Areas designated by the DNR.

## **Anadromous Fish Spawning Habitat**

Timber Harvest Plans must identify streams on or adjacent to the property that support spawning of anadromous fish such as rockfish, yellow perch, white perch, shad, and river herring.

The following criteria are to be used to protect anadromous fish spawning waters:

1. Artificial materials may not be introduced onto the bottom of natural streams unless it is shown that water quality and fisheries habitat will be improved.
2. Channelization, such as culverts or road crossings, which may change the course or circulation of a stream and interfere with the movement of the fish, is prohibited.

3. Sediment-laden runoff is minimized to the extent possible.
4. The natural vegetation of the watershed is maintained.
5. No structures that would interfere with the movement of spawning fish or larval forms are placed in streams.
6. Bridge activities or other stream crossings within the buffer or that occur instream are prohibited between March 1 and June 15.



## **APPENDIX F.3**

### **Procedural Requirements**

#### **Preparation of Timber Harvest Plans**

Timber Harvest Plans shall be prepared by a Maryland Licensed Forester (LPF). These would include private consultants, company foresters, and DNR service foresters. A completed plan shall include the stamp and number of the LPF. No format for a timber harvest plan is mandated, although the plan must contain information that addresses the Critical Area regulations.

The basic information includes landowner name and address, timber harvest location, and a map showing the location, size, and layout of the harvest. The critical area boundary, slopes over 15 percent and Habitat Protection Areas must be identified. The Timber Harvest Plan must describe the harvest method, regeneration method, confirmation of an erosion and sediment control plan, wildlife corridor layout, and allowances made for habitat continuity.

#### **Buffer Management Plans**

If harvesting is to occur within the 100-foot streamside buffer in the Critical Area, a Buffer Management Plan must be prepared in addition to the Timber Harvest Plan. This plan is needed to address particular protection requirements for the buffer.

All Timber Harvest Plans must delineate a minimum 100 foot buffer adjacent to tidal waters, tidal wetlands, and perennial tributary streams. A tributary stream may be tidal or nontidal. Commercial harvesting of trees by selection or by clear cutting of loblolly pine and tulip poplar may be permitted to within 50 feet of the mean high water line of tidal water, the edge of tidal wetlands, or the edge of perennial tributary streams. There are no specific buffer requirements under the Critical Area Law for intermittent streams; however, erosion and sediment control BMPs restrict cutting adjacent to intermittent streams to avoid sedimentation during fish spawning season.

#### **Submission and Review Process**

Plans should be submitted to the DNR - Forest Service Project Manager for the county in which the property is located. The Project Manager will submit complete Timber Harvest Plans to the District Forestry Board within five (5) weeks of receipt from the LPF. The District Forestry Board will review the plan, checklist, and comments and determine if the provisions of the local Critical Area Program are met.

#### **Approval and Appeal**

The approval process is a partnership between the District Forestry Board and the DNR-FS. The Timber Harvest Plan may be modified before approval by the District Forestry Board and the DNR-FS. Some counties require approval of plans by a county department in addition to DNR/District Forestry Board approval.

## **VariANCES**

If the literal enforcement of the approval requirements would result in unwarranted hardship to a landowner, they may request a variance from these requirements. The landowner should request the variance through the District Forestry Board.

### **Length Of Approval:**

Plan approvals are valid for three (3) years from the date of the District Forestry Board approval, or whatever approval length (if any) is indicated in the local Critical Area Program.

### **Appeal:**

Occasionally, conflicts arise where management recommendations are unacceptable to the landowner, or interpretations of the Critical Area regulations are disputed. There is a multi-level conflict resolution procedure to resolve these disputes. If this process does not result in a satisfactory solution, landowners or applicants may appeal to the Secretary of DNR. Further appeal may be conducted through the court system.

Copies of the complete Chesapeake Bay Critical Area Law and Regulations and guidance papers can be obtained from the

Chesapeake Bay Critical Area Commission  
1804 West Street, Suite 100  
Annapolis, MD 21401.

Local Critical Area Program information can usually be obtained from the local or county Planning and Zoning Office. Other documents may be obtained from the:

Maryland Department of Natural Resources - Forest Service  
Tawes State Office Building, Suite E-1  
580 Taylor Avenue  
Annapolis, MD 21401.

**APPENDIX G - I**  
**WATERWAY AND WETLAND REGULATIONS**

**APPENDIX G - GENERAL WATERWAY CONSTRUCTION PERMIT**

**APPENDIX H - NONTIDAL WETLANDS FORESTRY ACTIVITIES**

**APPENDIX I - NONTIDAL WETLANDS PLAN REVIEW AND APPROVAL  
FOR FORESTRY ACTIVITIES**

*Please note that the following copies of the regulations are provided as an unofficial reference. For legal and compliance matters an official version of COMAR can be obtained from: Division of State Documents P. O. Box 2249 Annapolis, Maryland 21404-2249 (410) 974-2486 or (800) 63- 9657.*

*Or on line at: [www.dsd.state.md.us](http://www.dsd.state.md.us)*



## APPENDIX G – GENERAL WATERWAY CONSTRUCTION PERMIT

### CODE OF MARYLAND REGULATIONS 26.17.04.10

#### General Waterway Constructions Permit

A. A person shall be permitted by this regulation to make changes in the course, current or cross section of the 100-year frequency floodplain if the conditions specified in this regulation for these activities are met and the project is not located in the stream channel or floodplain of a wild and scenic river as defined in Natural Resources Article §8-402, Annotated Code of Maryland. The changes include the following:

- (1) Clearing and grading activities in the 100-year floodplain when:
  - (a) Less than 5,000 feet of land area and less than 100 cubic yards of earth are disturbed,
  - (b) Habitable structures are not constructed, and
  - (c) Permanent obstructions are not created that would affect the hydraulic characteristics of the floodplain;
- (2) Temporary construction on the waters of the State which meet the special requirements of Regulation .08B, C, D, and E of this chapter; or
- (3) Minor maintenance and repair of existing structures that are located in the waters of the State.

B. In addition to the conditions imposed on the categories of construction activities set forth in §A of this regulation, an owner of a project site subject to general waterway construction permit shall do all of the following:

- (1) Provide the Administration with 30 days advance written notice of the planned construction activity including any required plans, specifications, and the construction schedule, and provide anticipated dates of the beginning of construction activity;
- (2) Allow reasonable inspection of the site by representatives of the Administration;
- (3) Maintain construction plans and specifications at the construction site for reasonable inspection by the Administration during construction;
- (4) When applicable, obtain an approved sediment and erosion control plan from the local soil conservation district before construction;
- (5) Provide for specifically designed measures, which shall be included in the construction plans, to minimize sediment pollutants from entering the waters of the State for those construction activities within a stream channel that are not subject to the requirements of COMAR 26.17.01.05, which requires an approved erosion and sediment control plan for certain activities;
- (6) Provide the Administration with written notice within 30 days after completion of the project.

---

### CODE OF MARYLAND REGULATIONS 26.17.04.08

#### Temporary Construction in a Stream Channel or Floodplain.

C. Temporary Access Crossings. The following special requirements shall apply to applications for temporary access crossings within the waters of the State:

- (1) Temporary access crossings shall conform to the technical requirements in the "1983 Maryland Standards and Specifications for Soil Erosion and Sediment Control" which is incorporated by reference under COMAR 26.17.01.11;
- (2) Earth embankments for an access road greater than 3 feet high may not be permitted;
- (3) The applicant shall submit the following information to the Administration:
  - (a) General plan of the proposed project showing:
    - (i.) Location;
    - (ii.) Land ownership;
    - (iii.) Cross section of presently existing stream channel;
  - (b) Construction plans and specifications;
  - (c) Type and source of materials to be used in construction;
  - (d) Erosion and sediment control provisions including design details and schedule of application.

## APPENDIX H

### NONTIDAL WETLANDS FORESTRY ACTIVITIES

#### CODE OF MARYLAND REGULATIONS 26.23.05.02

##### Forestry Activities

A. A person conducting a forestry activity is exempt from the requirements under this subtitle to obtain a nontidal wetland permit and to provide mitigation. Unless exempted in Section B of this regulation, a person conducting a forestry activity shall implement best management practices to protect nontidal wetlands through a sediment and erosion control plan submitted to and approved by a soil conservation district after December 31, 1990.

B. Exemptions. The following forestry activities shall be exempt from the plan approval requirements of this regulation and Regulation .03 of this chapter:

- (1) Repair and maintenance of existing structures associated with forestry activities in nontidal wetlands, including drainage ditches, roads, skid trails, causeways, bridges, culverts, and firebreaks, provided the repair and maintenance activities do not drain, dredge, fill, or convert nontidal wetlands.
- (2) Forestry activities on areas that have lain fallow due to disease eradication or before site preparation. A person conducting forestry activities shall implement best management practices when the land is no longer fallow and the area is replanted or allowed to regenerate.
- (3) Forestry activities on areas that have lain fallow after harvesting before replanting or regeneration due to a civil action involving ownership of the property. A person conducting forestry activities shall implement best management practices to protect nontidal wetlands upon resolution of the civil action.
- (4) Forestry activities on nontidal wetlands that have been set aside or taken out of production under a formal State or federal program for forest land for the time period of the set aside if change does not occur in land use. A person conducting forestry activities shall implement best management practices upon expiration of the time period of the set aside and when a new sediment and erosion control plan is required.
- (5) Forestry activities that do not require a sediment and erosion control plan.
- (6) Forestry activities that are begun before January 1, 1991, in accordance with a sediment and erosion control plan approved before January 1, 1991.

C. Intent of Best Management Practices. Best management practices for forestry activities in nontidal wetlands shall be designed to achieve the following goals:

- (1) Control soil loss and sediment deposition in nontidal wetlands;
- (2) Minimize water quality degradation caused by sediment;
- (3) Minimize adverse impacts to circulation patterns or flow of surface water or ground water;
- (4) Prevent a nontidal wetland from being changed to upland or any other area that no longer meets the nontidal wetland definition; and
- (5) Minimize adverse impacts to the chemical, physical, or biological characteristics of wetlands.

D. A soil conservation district shall consider the following factors in approving the use of best management practices for forestry activities in nontidal wetlands:

- (1) Properties of specific soils to resist compaction or ruts and support equipment;
- (2) Ability to maintain surface and ground water levels in the nontidal wetland after the harvest; and
- (3) Maintenance of the ecological value of nontidal wetlands of special State concern.

E. Best Management Practices.

- (1) A person conducting forestry activities in nontidal wetlands shall implement best management practices that meet the intent of §§ C and D of this regulation as set forth in a sediment and erosion control plan prepared by a registered professional forester, and approved by a soil conservation district that is consistent with this regulation and Regulation .03 of this chapter.
- (2) For skid trails, log decks, and roads, a person conducting a forestry activity shall use site specific best management practices approved by a soil conservation district. These best management practices may include:
  - (a) Locating major skid trails to the maximum extent feasible on soils that resist compaction, ruts, or other disturbances that adversely impact nontidal wetland hydrology.
  - (b) Selecting appropriate equipment to skid logs shall be based upon:
    - (i) Slope; and
    - (ii) Ability of the soil to resist erosion or other disturbance.
  - (c) Constructing forest roads:
    - (i) On uplands where feasible, or on the highest available ground if uplands are unavailable, so as to minimize encroachment into nontidal wetlands.
    - (ii) Using stabilization techniques to minimize erosion.
    - (iii) Following natural contours of the land, wherever feasible.
    - (iv) Maintaining the hydrology of the nontidal wetland by constructing diversion ditches at the minimum depth to maintain flow of water and using mats or similar temporary structures to reduce compaction or creation of ruts.
    - (v) By not using fill materials for forest roads or using the minimum amount of fill material necessary to maintain a road. Fill shall be excavated from uplands when feasible, and shall be free from State or federally designated toxic pollutants.
  - (d) Constructing stream crossings as to:
    - (i) Cross in the shortest distance feasible.
    - (ii) Be of appropriate design, considering the size of the stream and whether the crossing is temporary or permanent. Examples of these structures are mats, bridges, or culverts.
    - (iii) Allow unrestricted movement of aquatic life in the stream.
  - (e) Locating and maintaining log decks:
    - (i) On uplands when they are on-site or available;
    - (ii) As far from streams or nontidal wetlands as practicable or on the highest available ground if uplands are unavailable;
    - (iii) At a minimum size and number necessary for the operation;
    - (iv) With diversion ditches to direct water away from the deck during use;
    - (v) By collecting and disposing of trash, debris, and chemicals outside the nontidal wetland.
  - (f) Regrading and revegetating as necessary areas affected by skid trails, log decks, and temporary roads after harvesting is completed.
- (3) For harvest and regeneration practices, a person conducting a forestry activity shall use site-specific best management practices approved by a soil conservation district. These best management practices may include one or more of the following:
  - (a) Using high flotation equipment when nontidal wetland soils are unable to support conventional equipment or harvesting on frozen or dry nontidal wetland soils when these soils are capable of supporting equipment to prevent compaction, ruts, or other significant disturbances to nontidal wetland soils or hydrology.
  - (b) Conducting forestry activities so as to prevent impoundment of water or increased runoff in the nontidal wetland, unless the change is recommended in a sediment and erosion control plan.
  - (c) Employing site preparation methods that do not result in the conversion of nontidal wetland to upland by grading, bedding, or other disturbances to the soil.
  - (d) Complying with the seed tree law.
  - (e) Employing natural regeneration as the preferred method of regeneration in nontidal

- wetlands, excluding nontidal wetlands with loblolly pine that are regulated under the seed tree law and nontidal wetlands described in § E(3)(f) of this regulation, if surface water is present for at least 1 month of the growing season and high ground water is present for most of the growing season. Presence of surface or high ground water can be determined by:
- (i.) Visual observation;
  - (ii.) Soil samples; or
  - (iii.) Other hydrological indicators that are described in the Federal Manual.
- (f) Managing nontidal wetlands with at least 20 percent of the live trees being Atlantic white cedar (*Chamaecyparis thyoides*), red spruce (*Picea rubens*), balsam fir (*Abies balsamea*), American larch (*Larix laricina*), or bald cypress (*Taxodium distichum*) to maintain at least the same distribution after harvest.
- (4) For nontidal wetlands of special State concern, a person conducting a forestry activity shall use site-specific best management practices approved by a soil conservation district under all of the following criteria:
- (a) These best management practices shall maintain the ecological value of nontidal wetlands of special State concern by establishing:
    - (i) A primary protection area for the crucial portions of nontidal wetlands of special State concern within which a disturbance may not occur, and
    - (ii) A secondary protection area, when appropriate, within the nontidal wetland of special State concern where group selection, single tree selection, natural regeneration, limited skidder access, disturbance restrictions during the breeding and nesting season, and other low-impact techniques shall be used; and
  - (b) Practices to maintain the ecological value of nontidal wetlands of special State concern may not be such that harvesting is prohibited within the secondary protection area provided that best management practices are consistent with § E (4)(a)(ii) of this regulation and this section.
- F. Best management practices for loblolly pine nontidal wetlands that are regulated by the seed tree law shall be simplified and limited to practices listed under § E(1), (2), and (3)(a)-(d) of this regulation, as appropriate to a specific site. .



## APPENDIX I

### NONTIDAL WETLANDS PLAN REVIEW AND APPROVAL FOR FORESTRY ACTIVITIES

#### CODE OF MARYLAND REGULATIONS 26.23.05.03

##### Plan Review and Approval for Forestry Activities

A. A soil conservation district shall obtain and consider all of the following information to determine which best management practices are necessary and appropriate:

- (1) A delineation according to the Federal Manual of the extent of nontidal wetlands affected by forestry activities including acreage of nontidal wetland to be harvested.
- (2) The method and schedule for harvesting as prepared by a registered professional forester.
- (3) A description of equipment to be used to conduct forestry activities in nontidal wetlands.
- (4) The estimated location of:
  - (a) Major skid trails;
  - (b) Log decks; and
  - (c) Roads.
- (5) The proposed location of diversion ditches.
- (6) A description of anticipated site preparation methods. Methods may include one or more of the following, as appropriate:
  - (a) Bedding;
  - (b) Stabilization;
  - (c) Additional clearing or stump removal;
  - (d) Chemical treatment.
- (7) Description of measures to rectify disturbances from temporary forest roads, log decks, skid trails, and other temporary structures as necessary.
- (8) The proposed planting or regeneration method.
- (9) Forestry activities and protection areas in nontidal wetlands of special State concern described in Regulation .02E(4) of this chapter.

B. A person conducting forestry activities in loblolly pine nontidal wetlands regulated under the seed tree law may submit a reforestation plan, instead of the information requirements of §A of this regulation, to a soil conservation district to expedite a review of a sediment and erosion control plan if the reforestation plan:

- (1) Contains information required under §A of this regulation to approve best management practices appropriate to the site; and
- (2) Has been approved by the Department.

C. Plan Processing and Approval.

- (1) A soil conservation district shall:
  - (a) Delineate or review and approve the delineation of nontidal wetlands according to the Federal Manual; and
  - (b) Review and approve the sediment and erosion control plan if it complies with this regulation and Regulation .02 of this chapter.
- (2) A soil conservation district may use guidance maps prepared by the Department to assist in the identification of nontidal wetlands of special State concern.
- (3) The Department shall delineate the primary and secondary protection areas for nontidal wetlands of special State concern in consultation with a soil conservation district. Comments from the landowner and the registered professional forester prescribing the harvest method and schedule shall be considered.

- (4) A person conducting forestry activities shall:
  - (a) Submit copies of an approved sediment and erosion control plan to the Department; and
  - (b) Notify the soil conservation district when site conditions require a change in best management practices.
- (5) A person conducting forestry activities in nontidal wetlands on State lands shall submit sediment and erosion control plans to the Department for approval.
- (6) The Department shall recommend additional voluntary protection standards for forestry activities in nontidal wetlands upon request from a person conducting forestry activities.
- (7) Forestry activities in nontidal wetlands shall be subject to the enforcement provisions of COMAR 26.23.01.05.
- (8) A soil conservation district shall cooperate with the Department to resolve a violation of these regulations caused by a forestry activity.

## APPENDIX J

### STANDARDS AND SPECIFICATIONS FOR GEOTEXTILE MATERIALS

		WOVEN SLIT FILM GEOTEXTILE		WOVEN MONOFILAMENT GEOTEXTILE		NONWOVEN GEOTEXTILE	
		MINIMUM AVERAGE ROLL VALUE <sup>1</sup>					
PROPERTY	TEST METHOD	MD	CD	MD	CD	MD	CD
Grab Tensile Strength	ASTM D-4632	200 lb	200 lb	370 lb	250 lb	200 lb	200 lb
Grab Tensile Elongation	ASTM D-4632	15%	10%	15%	15%	50%	50%
Trapezoidal Tear Strength	ASTM D-4533	75 lb	75 lb	100 lb	60 lb	80 lb	80 lb
Puncture Strength	ASTM D-6241	450 lb		900 lb		450 lb	
Apparent Opening Size <sup>2</sup>	ASTM D-4751	U.S. Sieve 30 (0.59 mm)		U.S. Sieve 70 (0.21 mm)		U.S. Sieve 70 (0.21 mm)	
Permittivity	ASTM D-4491	0.05 sec -1		0.28 sec -1		1.1 sec -1	
Ultraviolet Resistance Retained at 500 hours	ASTM D-4355	70% strength		70% strength		70% strength	

<sup>1</sup> All numeric values except apparent opening size (AOS) represent minimum average roll values (MARV). MARV is calculated as the typical minus two standard deviations. MD is machine direction; CD is cross direction.

<sup>2</sup> Values for AOS represent the average maximum opening.

Geotextiles must be evaluated by the National Transportation Product Evaluation Program (NTPEP) and conform to the values in the above table.

The geotextile must be inert to commonly encountered chemicals and hydrocarbons and must be rot and mildew resistant. The geotextile must be manufactured from fibers consisting of long chain synthetic polymers and composed of a minimum of 95 percent by weight of polyolefins or polyesters, and formed into a stable network so the filaments or yarns retain their dimensional stability relative to each other, including selvages.

When more than one section of geotextile is necessary, overlap the sections by at least one foot. The geotextile must be pulled taut over the applied surface. Equipment must not run over exposed fabric.

Source:

*2011 Maryland Standards and Specifications for Soil Erosion and Sediment Control*

## APPENDIX K REFERENCES

- Allen, H. L.; Campbell R. G. *Wet Site Pine Management in the Southeastern United States*.
- Brown, Hilda J. *Publications of the Southeastern Forest Experiment Station, 1959-1963*, (1965) :65. Originally published in Jack Stubbs, "Wetland Forests" *Forest Farmer*. (1962).
- Florida Division of Forestry and Florida Forestry Association. "Management Guidelines For Forested Wetlands in Florida." (August 1987).
- Kessler, George D., Jack T. May, and Donald D. Hook. "Soil-Tree Growth Relationships In An Upper Coastal Plain Swamp." *Tree growth and forest soils: proceedings of the third North American soils conference held at North Carolina State University at Raleigh in August 1968*. (1968): 475-476.
- Letich, Jay A. and Leonard A. Shabman. "Overview Of Economic Assessment Methods Relevant To Wetland Evaluation." *The Ecology and Management of Wetlands 2* (1988).
- Megahan, Walter F. and Peter N. King. "Identification of Critical Areas on Forest Lands for Control of Nonpoint Sources of Pollution." *Environmental Management 9*(1) (1985): 7-17.
- Maryland Department of the Environment. "1994 Maryland Standards and Specifications For Soil Erosion and Sediment Control." (1994).
- Maryland Department of the Environment. "2011 Maryland Standards and Specifications For Soil Erosion and Sediment Control." (2011).
- Riekerk, Hans. "The Impacts of Silviculture on Flatwood Runoff, Water Quality, and Nutrient Budget." *Journal of the American Water Resources Association 19* (1983): 73-79.
- Trimble, George R. and Sartz, Richard S. "How Far From A Stream Should A Logging Road Be Located?" *Journal of Forestry* (1957).
- U.S. Department of Agriculture, Natural Resources Conservation Service. "Maryland Conservation Practice Standard, Critical Area Planting, Code 342." (April 2013).
- U.S. Fish and Wildlife Service, U.S. Department of the Interior. "Impact of Water Level Changes on Woody Riparian and Wetland Communities." *The Southern Forest Region 1* (December 1977).
- U.S. Fish and Wildlife Service, U.S. Department of the Interior. "The Ecology of Bottomland Hardwood Swamps of the Southeast: A Community Profile." (March 1982).
- U.S. Fish and Wildlife Service, U.S. Department of the Interior. "The Ecology of Southeastern Shrub Bogs (Pocosins) and Carolina Bays: A Community Profile." (November 1982).